

2025

# PRODUCT CATALOG

ADVERTISING MEDIA AND DISPLAY SYSTEMS  
FOR PRINTING HOUSES AND ADVERTISING AGENCIES

myAD | vyrábame  
reklamu

WE MEET  
EXPECTATIONS



# TABLE OF CONTENTS

## INDOOR

<b>LED It's time to shine!</b>	<b>5</b>	Black Pro Magnetic Pop-Up Arc	57	LED BOX™ Counter	79
LUMIX™ System	6	Velcro Pop-Up Straight	58	Brochure holders	80
LED BOX™	8	Velcro Pop-Up Arc	59	Montana Silver	80
LED BOX™ Silver	8	Atlantis Straight	60	Montana Black	81
LED BOX™ Black	9	Atlantis Arc	61	Boston	82
LED BOX™ Flex	10	Atlantis S-Shape	62	Atlanta	82
LED BOX™ Plus	12	Atlantis U-Shape	63	Columbia	83
LED BOX™ Wall Frame	13	Conference Room	63	Lincoln	83
LUMIX™ Counter	14	Combi 1	64	Counter Dallas	84
LED BOX™ Counter	15	Combi 2	64	Counter Concord	84
Preston Automatic LED Counter	16	Versum	65	Counter Virginia	84
Preston Automatic Oval LED	16	Versum XI	65		
Preston Automatic Rectangle LED	16	Advertising Wall Accessories	66		
				<b>POSTER FRAMES &amp; RAILS</b>	<b>85</b>
<b>ROLL UP</b>	<b>17</b>	<b>EXHIBITION BOOTHS</b>	<b>67</b>	Poster Rails	86
Compact	18	LUMIX™	68	Standard	87
Standard	20	LUMIX™ Exhibition Booths Accessories	70	Slim	87
Standard Plus	22	Monitor Holder	70	Clip	87
Classic	24	Locker Set	70	Twin	87
Basic	26	Shelves System	70	Vertico Hanging Frames	88
Premium	28			Snap Frames Standard	89
Pro	30			Snap Frames Silver	89
Exclusive	32	<b>COUNTERS &amp; BROCHURE HOLDERS</b>	<b>71</b>	Snap Frames Black	89
Exclusive Black	34	Promo Counters	72	Snap Frames Premium	90
Wave	36	Promo 0	72	Magnetic Frames	91
Twin	38	Promo 1	72	Magnetic	91
Standard Black	40	Promo 2	73	Magnetic Rewers	91
Roll Up Accessories	42	Promo 3	73	Magnetic Safety	91
		Promo 4	73	Door Signs	92
<b>STANDS</b>	<b>43</b>	Preston Counters	74	Sonic	92
X-Banner Compact	44	Preston Oval	74	Gert	92
X-Banner Standard	44	Preston Triangle	74	Elite	93
L-Banner Premium	45	Preston Waist	75	Puro	93
L-Banner Premium Twin	45	Preston Rectangle	75	Manta	93
Atlantis Expo	46	Preston XXL	75	Acrylic Stands	94
		Pop-Up Velcro	76	Crystal	94
<b>ADVERTISING WALLS</b>	<b>47</b>	Pop-Up 2x1	76	Platinum	94
Mega Seg™ System	48	Pop-Up 2x2	76	Vista	95
Pop-Up Straight	50	Promo 2 Plus	77	Rod Systems	96
Pop-Up Arc	51	Topper	77	Wall To Wall System	96
Standard Magnetic Pop-Up Straight	52	Preston Automatic Counters	78	Wall To Floor/Ceiling System	96
Standard Magnetic Pop-Up Arc	53	Preston Automatic Oval	78	Ceiling To Floor System	97
Premium Magnetic Pop-Up Straight	54	Preston Automatic Oval LED	78	Ceiling To Board System	97
Premium Magnetic Pop-Up Arc	55	Preston Automatic Rectangle	78	Accessories	98
Black Pro Magnetic Pop-Up Straight	56	Preston Automatic Rectangle LED	78	Standoffs	98
		LUMIX™ Counter	79		

## OUTDOOR

<b>PAVEMENT SIGNS</b>	<b>99</b>	<b>QUEUE BARRIER</b>	<b>116</b>	<b>TENT FRAMES</b>	<b>129</b>
Aurora	100	Premium	116	Tent Frames	130
Spider	101	Replacement Heads	116	Tent Canopy	132
Hampton	102	Hotel Barrier	117	Accessories	132
Hampton Pro	103	Royal Chrome	117		
Info Stand Chroma	104	Modern Chrome	117	<b>EVENT FURNITURES</b>	<b>133</b>
Info/Menu Stand Puladi	105	Royal Gold	117	Tables	134
Info/Menu Stand Classic	106	Modern Gold	117	Cocktail Table 80	134
Info/Menu Stand Standard	106	Velvet Border	117	Event Table 180x75	134
Info/Menu Stand Premium	107	Laced Border	117	Event Table Round 122	134
Metal Easel	108	Barrier Post Info Frame	118	Table Header	135
		Wall Mounted Head	118	Tablecloth	135
<b>WOODEN PRODUCTS</b>	<b>109</b>	<b>FLAG POLES</b>	<b>119</b>	Tablecloth 80	135
Chalkboard Signs	110	Standard Pole	120	Tablecloth 122	135
Classic	110	Pro Pole	121	Tablecloth 180	135
Classic Natural	110	Twister Standard	122	Chairs	136
Chalkboard Sign Pro Waterproof	111	Twister Shark Fin	122	Folding Chair	136
Liquid Chalk Markers	111	H Poles	123	Cocktail Chair	136
Chalkboard	112	Avenue	123	Coctail Chair Cover	136
Table Stands	112	Pole Base	124		
Easel	113	Rotators	128		
Wooden Lounger	114				





# NEW TOP HITS

## HAMPTON PRO

Pavement sign with **enhanced water resistance parameters**. Wide **aluminium frame (40 mm)** is mounted on springs, thanks to which the sign adjusts to the wind. The base, once filled up, makes the system very heavy and stable. A snap frame allows to insert/exchange a poster within few seconds.

More info – page 103



-   
ENHANCED WATER RESISTANCE PARAMETERS
-   
WIND RESISTANCE
-   
QUICK GRAPHICS EXCHANGE (SNAP FRAME)
-   
POSTER COVER WITH UV-FILTER
-   
DOUBLE SIDED

## LED BOX™ FLEX

Double-sided, illuminated system that you unfold with one motion. **LED BOX™ FLEX is distinguished by its hinge-based design, which just needs to be unfolded.** Thanks to this mechanism, the entire product can be unfolded literally in seconds. Integrated LED lighting powered by quick-connectors results in **power cables being hidden in the aluminium profiles.**

More info – page 10-11







-   
HINGE-BASED CONSTRUCTION
-   
POWER VIA QUICK-CONNECTORS
-   
NO TOOLS
-   
DOUBLE SIDED
-   
SILICONE TAPE MOUNTED PRINTOUT

## LUMIX™ EXHIBITION BOOTHS

Illuminated, eye catching and no tools assembly - these are only a few advantages of the LUMIX exhibition booths. Several dozen LED bulbs guarantee an amazing effect of presented graphics. **High quality, easy assembly and long life are ensured by thick aluminium frame (12 cm) and silicone tape mounted printout.**

More info – page 68-69



-   
WIDE ALUMINIUM PROFILE
-   
NO TOOLS
-   
DOUBLE SIDED
-   
SILICONE TAPE MOUNTED PRINTOUT



*It's time to shine!*

LED

# LUMIX™ SYSTEM

PREMIUM LINE



-   
LED
-   
MODULAR EXPANSION OPTION
-   
12 cm  
WIDE ALUMINIUM PROFILE
-   
NO TOOLS
-   
SILICONE TAPE MOUNTED PRINTOUT
-   
WHEELED BAG

**UK** ■ double-sided, eye-catching LED system  
 ■ **wide aluminium profile (12 cm)**  
 ■ no tools assembly  
 ■ silicon tape mounted printout  
 ■ sturdy wheeled transport bag  
 The set includes: LUMIX system, power adapter, transport bag.

**DE** ■ doppelseitige, auffällige LED-System  
 ■ **breiter Aluminiumrahmen (12 cm)**  
 ■ werkzeuglose Montage  
 ■ mit Silikonband befestigte Ausdrucke  
 ■ robuste Transporttasche auf Rädern  
 Das Set enthält: LUMIX-System, Netzteil, Tasche auf Rädern.

**FR** ■ éclairage LED intégré  
 ■ construction recto-verso attirant tous les regards  
 ■ **profilé large en aluminium (12 cm)**  
 ■ montage sans outils  
 ■ l'image montée à l'aide d'une bande silicone  
 ■ sac à roulettes  
 Le kit comprend: un système LUMIX, alimentation, un sac de transport à roulettes.

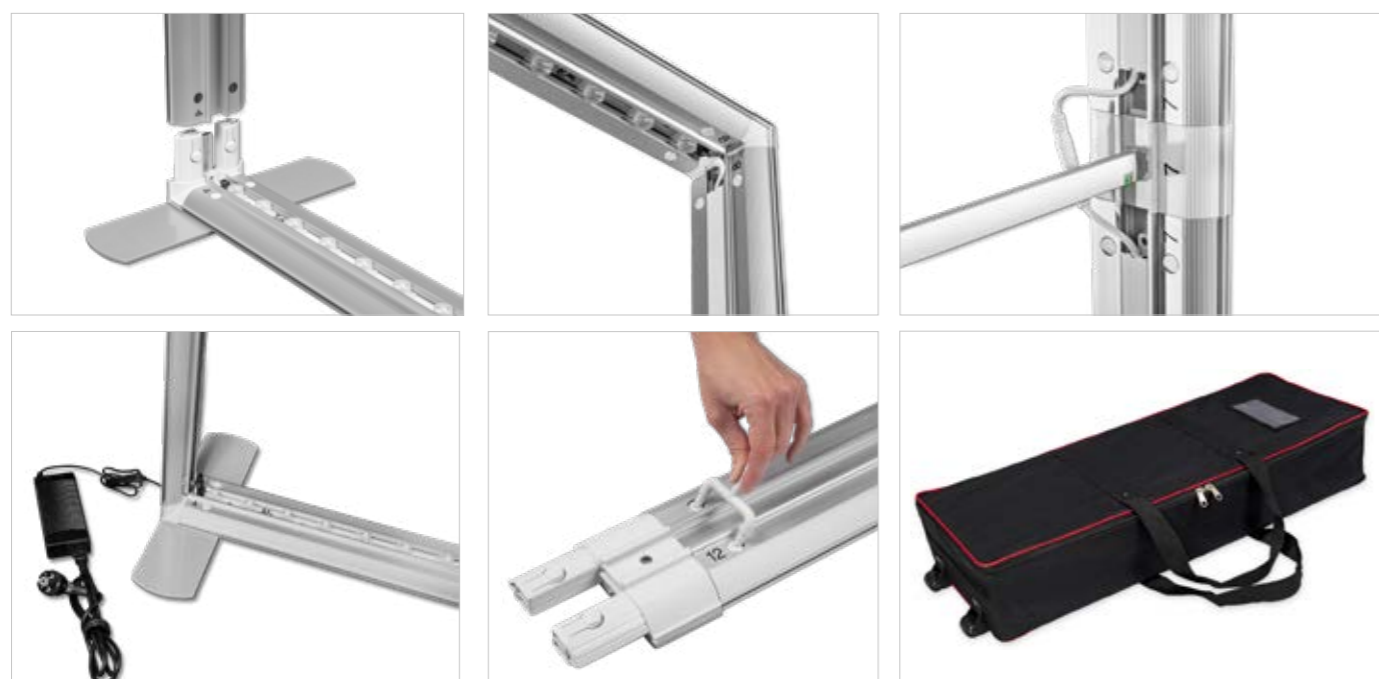

The LUMIX systems can be expanded thanks to modular construction. They can also be connected to each other for creating unique exhibition booths.

**CHECK OUR READY-MADE EXHIBITION BOOTHS - PAGES 68-69**



**MONITOR HOLDER, LOCKER SET AND SHELVES SYSTEM MAKE THE LUMIX PRODUCTS EVEN MORE FUNCTIONAL.**



**The Long Set enables to heighten the LUMIX system by 50 cm - up to 300 cm.**

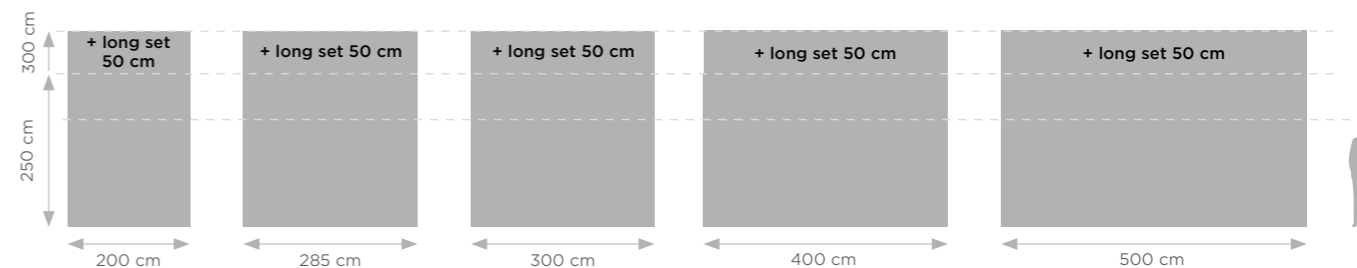

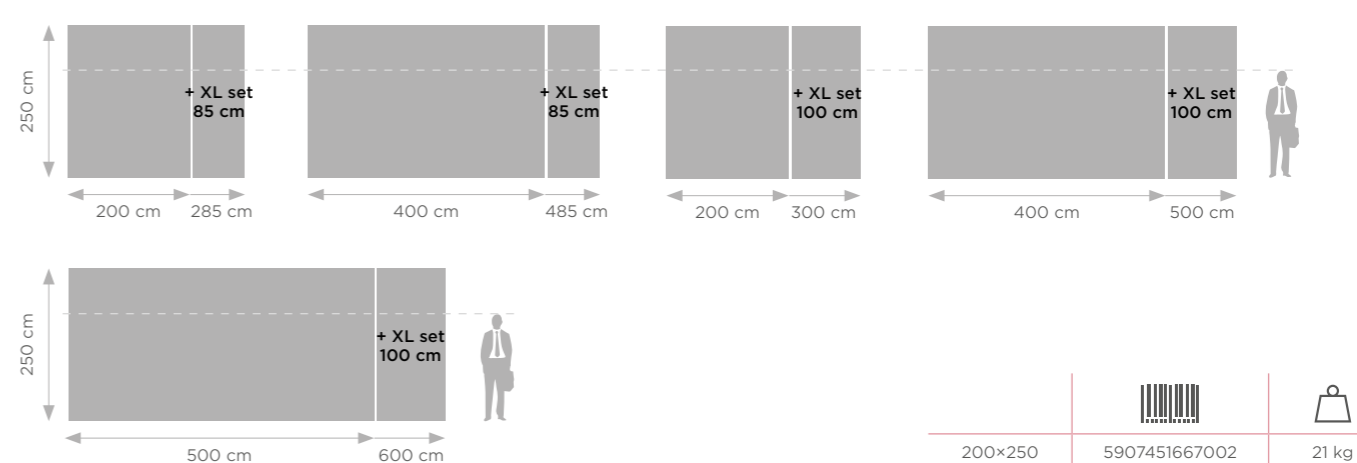

**The XL Set enables to increase the LUMIX system width by 85 or 100 cm.**



Recommended media and printing technology for this system:



Fabric Sublimation printing

		
200x250	5907451667002	21 kg
285x250	5907451667187	26 kg
300x250	5907451667019	27 kg
400x250	5907451667026	29 kg
500x250	5907451667033	36 kg

# LED BOX™

- double-sided LED system
- durable aluminium frame (8 cm)
- design based on quick-connects for powering the integrated LED lighting

The set includes: LED BOX, parallel connectors, power adapter, silicon tape, cardboard case.

- beidseitiges LED-System
- stabiler Aluminiumrahmen (8 cm)
- Konstruktion auf Basis von Schnellanschlüssen für die Stromversorgung der integrierten LED-Beleuchtung

Das Set enthält: LED BOX, serielle Anschlüsse, Netzteil, Silikonband, Transportkoffer aus Karton.

- système LED double face
- construction en aluminium (8 cm)
- construction basée sur des connecteurs rapides alimentant

Le kit comprend: système LED BOX, des connecteurs en série, une alimentation, ruban silicone, valise en carton.



# LED BOX™ SILVER

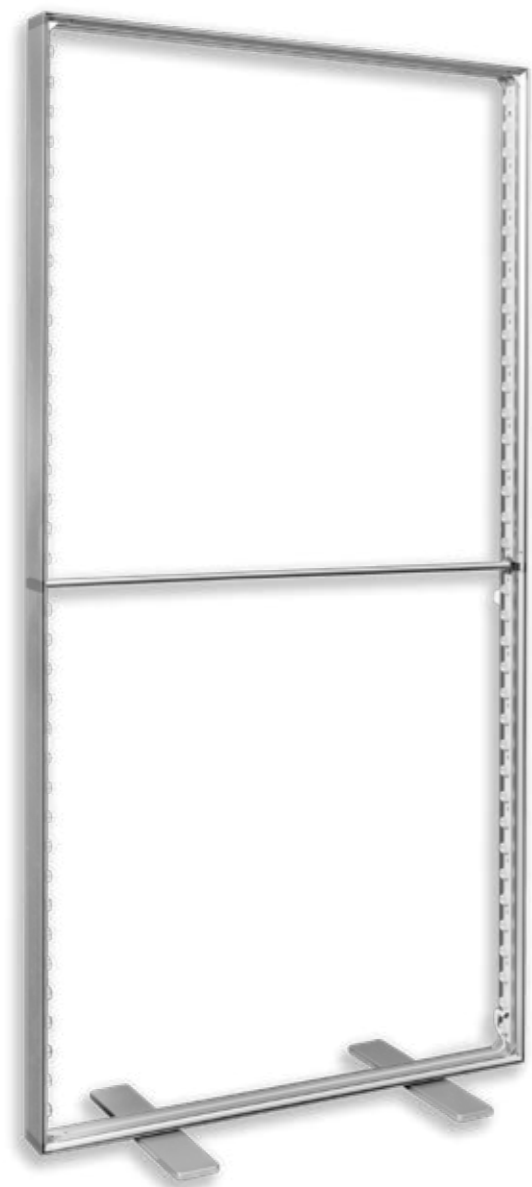

# LED BOX™ BLACK

NEW!



LED BOX PRODUCTS CAN BE CONNECTED TO EACH OTHER USING PARALLEL OR CORNER CONNECTORS.



	Barcode	Weight
100x200 (silver)	5907451664001	9,2 kg
100x230 (silver)	5907451669921	10 kg
100x250 (silver)	5907451669914	12 kg
100x200 (black)	5907451667507	9,2 kg
100x230 (black)	5907451667514	10 kg
100x250 (black)	5907451667521	12 kg

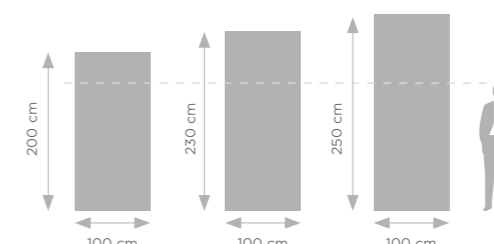

Recommended media and printing technology for this system:



# LED BOX™ FLEX

**NEW!**

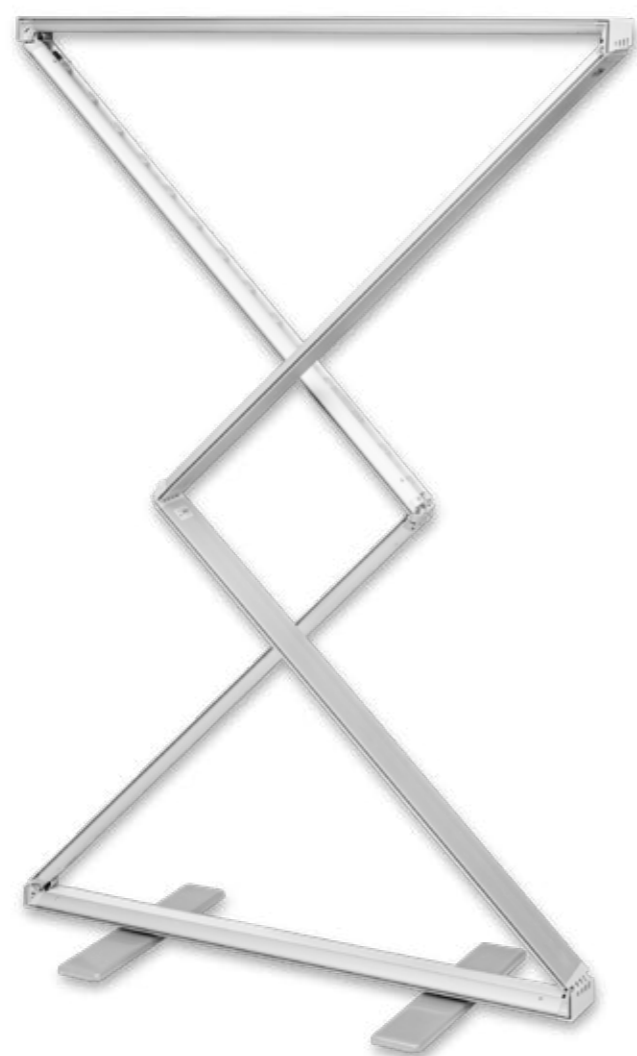

- **hinge-based construction = express unfolding**
  - durable aluminium frame (8,5 cm)
  - **Integrated LED lighting powered by quick-connectors (power cables hidden in the aluminium profiles)**
  - option to combine products
  - silicon tape mounted printout
  - no tools assembly
- The set includes: LED BOX FLEX, power adapter, transport bag.

- **scharnierbasiertes Design = schnelles Entfaltungs-system**
  - Aluminiumrahmen (8,5 cm)
  - **integrierte LED-Beleuchtung, die über Schnellkupp-lungen betrieben wird (die Stromkabel sind in den Aluminiumprofilen verborgen)**
  - werkzeuglose Montage
  - Möglichkeit Produkte zu kombinieren
  - Silikonband montiert Ausdruck
- Das Set enthält: LED BOX FLEX, Netzteil, Transport-tasche.

- **conception basée sur des charnières = système de dépliage express**
  - profilé aluminium (8,5 cm)
  - **l'éclairage LED intégré, alimenté par des connec-teurs rapides (câbles d'alimentation dissimulés dans les profilés en aluminium)**
  - montage sans outils
  - possibilité de combiner les produits
  - l' image montée à l'aide d'une bande silicone
- Le kit comprend: LED BOX FLEX, une alimentation, un sac de transport.

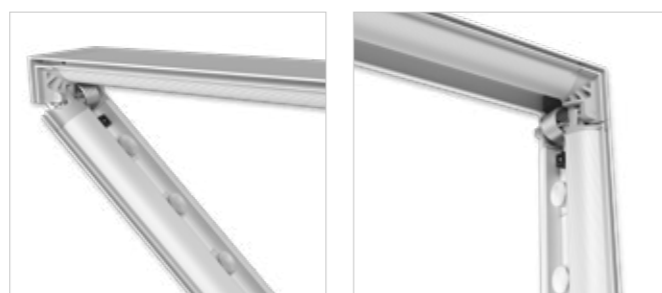

LED BOX FLEX IS DISTINGUISHED BY ITS HINGE-BASED CONSTRUCTION, WHICH SIMPLY NEEDS TO BE OPENED.

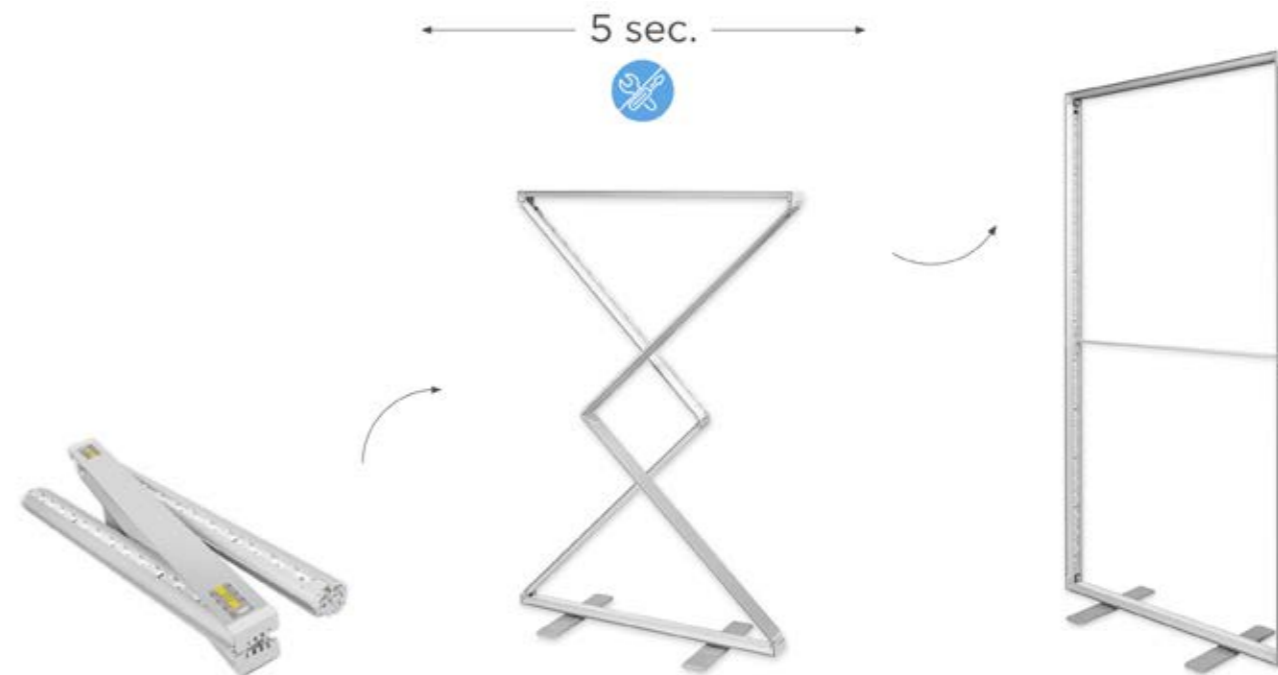

THANKS TO EMBEDDED MAGNETS, THE LED BOX FLEX PRODUCTS CAN BE CONNECTED IN SERIES TO EACH OTHER FOR CREATING SYSTEMS OF DIFFERENT SIZE.



100x200	5907451667415	7 kg
---------	---------------	------

Recommended media and printing technology for this system:

Fabric Sublimation printing

# LED BOX™ PLUS



- LED
- 10 cm WIDE ALUMINIUM PROFILE
- POWER VIA QUICK-CONNECTORS
- SILICONE TAPE MOUNTED PRINTOUT
- NO TOOLS
- DOUBLE SIDED



Size	Barcode	Weight
200x200	5907451668870	15 kg
300x200	5907451668856	22 kg
200x230	5907451668863	16 kg
300x230	5907451668849	23 kg

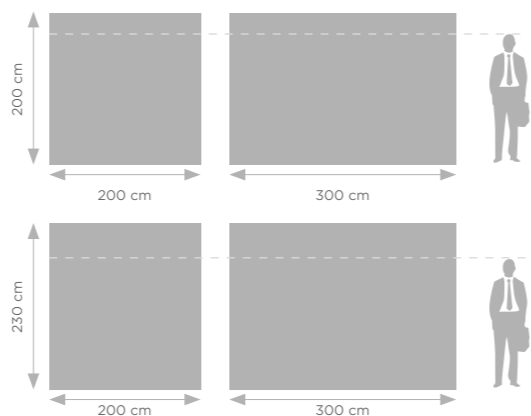

Recommended media and printing technology for this system: Fabric Sublimation printing

- double-sided illuminated system
- wide aluminium frame (10 cm)
- design based on quick-connects for powering the integrated LED lighting
- additional masking strip protects the bulbs from damage or breakage

The set includes: LED BOX PLUS wall, power adapter, silicon tape, transport bag.

- beidseitig beleuchtetes System
- breiter Aluminiumrahmen (10 cm)
- Konstruktion auf Basis von Schnellanschlüssen für die Stromversorgung der integrierten LED-Beleuchtung
- zusätzlicher Abdeckstreifen schützt die Leuchtmittel vor Beschädigung oder Bruch

Das Set enthält: Messewand LED BOX PLUS, Netzteil, Silikonband, Transporttasche.

- système double face et rétroéclairé
- profilé aluminium large (10 cm)
- construction basée sur des connecteurs rapides alimentant
- une barre de masquage supplémentaire protège les ampoules contre les dommages ou la fracture

Le kit comprend: un mur LED BOX PLUS, un ruban silicone, une alimentation, un sac de transport.

# LED BOX™ WALL FRAME NEW!



- LED
- 8 cm ALUMINIUM PROFILE
- SILICONE TAPE MOUNTED PRINTOUT
- NO TOOLS

- double-sided, suspended LED system
  - durable aluminium frame (8 cm)
  - no tools assembly
  - silicon tape mounted printout
- The set includes: LED BOX WALL FRAME, mounting accessories, power cable.

- beidseitiges LED-Hängesystem
  - stabiler Aluminiumrahmen (8 cm)
  - Montage ohne Werkzeug
  - Silikonband montiert Ausdruck
- Das Set enthält: LED BOX WALL FRAME, Montagezubehör, Versorgungskabel.

- système LED suspendu et éclairé
  - montage sans outils
  - l' image montée à l'aide d'une bande silicone
  - construction en aluminium (8 cm)
- Le kit comprend: LED BOX WALL FRAME, accessoires de montage, une alimentation.

Barcode	Weight
5907451666425	4,5 kg

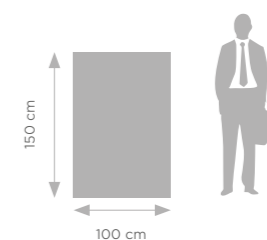

Recommended media and printing technology for this system: Fabric Sublimation printing

# LUMIX™ COUNTER

NEW!

PREMIUM LINE



- LED
- 12 cm  
WIDE ALUMINIUM PROFILE
- SILICONE TAPE MOUNTED PRINTOUT
- NO TOOLS
- DOUBLE SIDED
- WHEELED BAG

- double-sided system
  - wide aluminium profile (12 cm)**
  - integrated LED lighting
  - no tools assembly
  - silicon tape mounted printout
  - wheeled transport bag
- The set includes: LUMIX counter, power adapter, wheeled transport bag.

- doppelseitige, auffällige Konstruktion
  - stabiler Aluminiumrahmen (12 cm)**
  - integrierte LED-Beleuchtung
  - Silikonband befestigte Druck
  - werkzeuglose Montage
  - Tasche auf Rädern
- Das Set enthält: Theke LUMIX, Netzteil, Tasche auf Rädern.

- système double face
  - large profilé en aluminium (12 cm)**
  - éclairage LED intégré
  - assemblage sans outils
  - impression sur ruban adhésif siliciné
  - sac de transport à roulettes
- Le kit comprend: un comptoir LUMIX, une alimentation, un sac de transport à roulettes.



5907451667422 10 kg

Recommended media and printing technology for this system:



# LED BOX™ COUNTER



- LED
- 8 cm  
ALUMINIUM PROFILE
- SILICONE TAPE MOUNTED PRINTOUT
- NO TOOLS
- DOUBLE SIDED

- double-sided LED system
  - durable aluminium frame (8 cm)
  - no tools assembly
  - silicon tape mounted printout
- The set includes: LED BOX counter, power adapter, transport bag.

- beidseitiges LED-System
  - stabiler Aluminiumrahmen (8 cm)
  - Montage ohne Werkzeug
  - Silikonband montiert Ausdruck
- Die Set enthält: Theke LED BOX, Netzteil, Transporttasche.

- rétroéclairé, double face et facile à utiliser
  - aluminium anodisé solide (8 cm)
  - montage sans outils
  - l'image montée à l'aide d'une bande silicone
- Le kit comprend: un comptoir LED BOX, une alimentation, un sac de transport.



5907451669815 7 kg

Recommended media and printing technology for this system:





## PRESTON AUTOMATIC LED COUNTER

- automatic, no tools assembly
- LED system
- silicone tape mounted print-out

The set includes: PRESTON counter, transport bag.

- automatische Montage ohne Werkzeug
- LED-System
- Silikonband montiert Ausdruck

Die Set enthält: Theke PRESTON, Transporttasche.

- dépliage automatique du comptoir
- éclairage LED intégré
- l'image lumineuse montée avec une bande en silicone

Le kit comprend: un comptoir PRESTON, un sac de transport.

Recommended media and printing technology for this system:

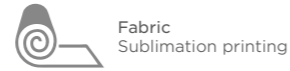

### PRESTON AUTOMATIC OVAL LED

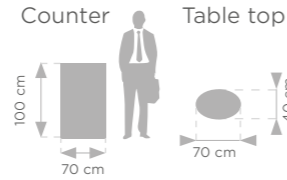
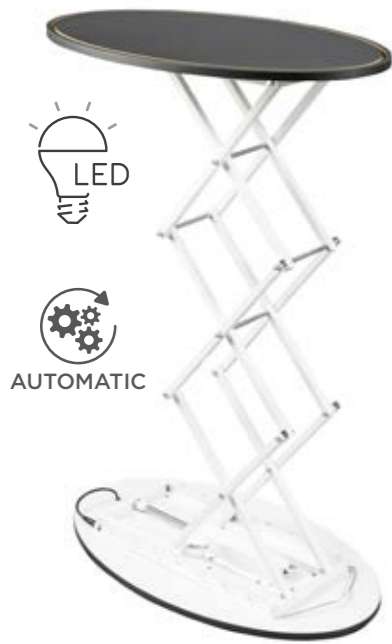

### PRESTON AUTOMATIC RECTANGLE LED

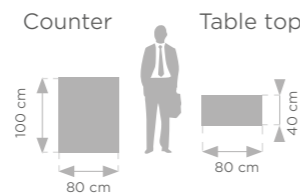

**ROLL UP**

# COMPACT

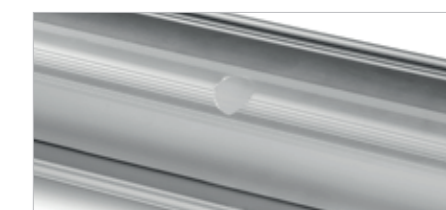
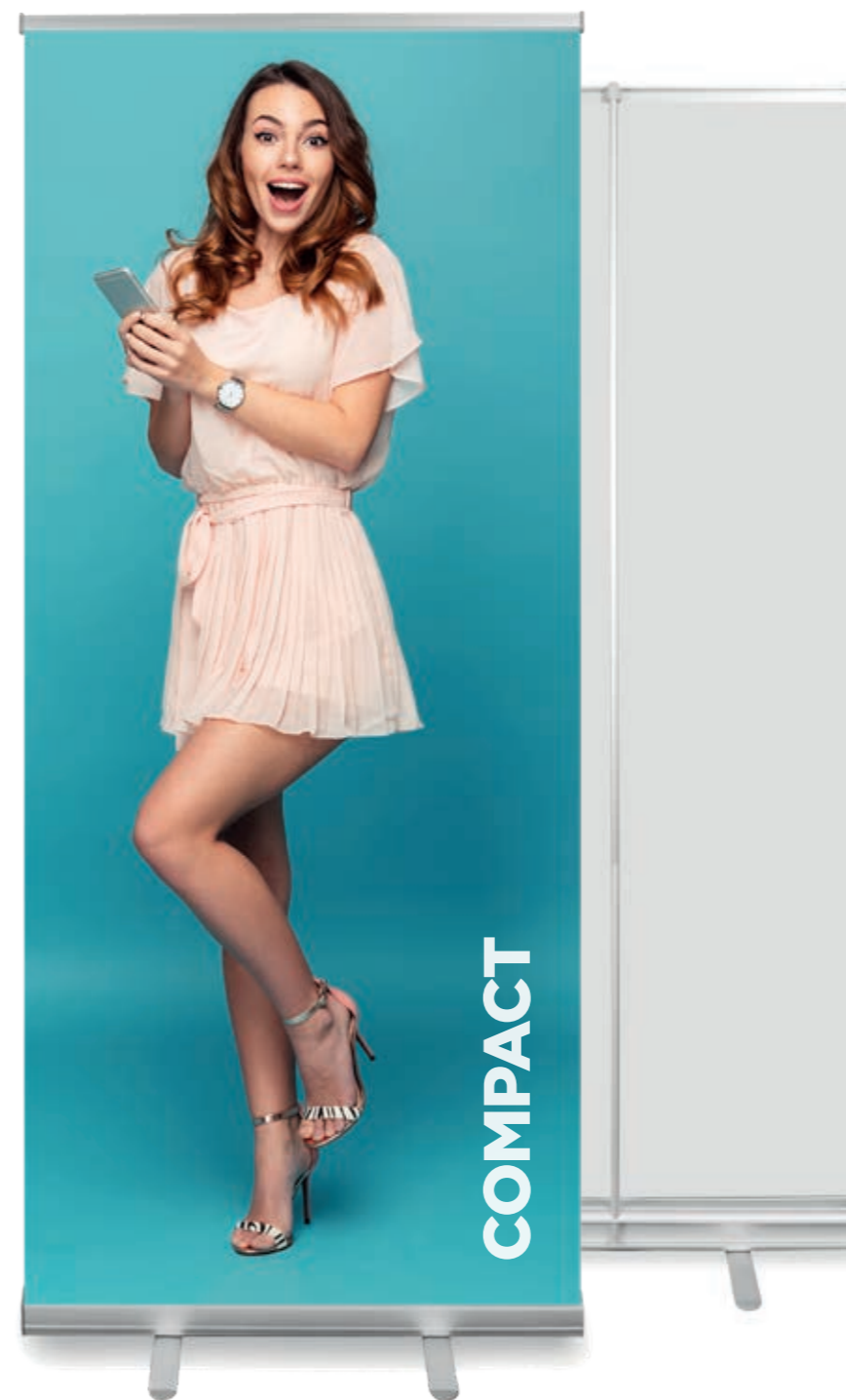

- price leader!
- small, compact and easy to carry
- cassette dimension reduced from 9,3 to 8,3 cm
- "Express Clip" top bar - quick and easy print assembly
- economy class product, valued for big adv campaigns

This set includes: Compact roll up cassette, pole, "Express Clip" top bar with 3M adhesive tape, bag with business card pocket.

- Preisführer unter den Roll-Ups!
- klein, kompakt und leicht zu tragen.
- Durchmesser der Kassette von 9,3 auf 8,3 cm reduziert
- "Express Clip" obere Leiste - schnelle und einfache Druckmontage
- Economy Class-Produkt, das für große Adv-Kampagnen geschätzt wird

Dieses Set enthält: Compact Roll-Up-Kassette, Mast, Einrastleiste "Express Clip" mit 3M Klebeband, Transporttasche mit Fenster für Visitenkarte.

- leader des prix parmi les roll-ups
- petit, compact, facile à transporter
- le diamètre de la cassette a été réduit à 8,3 cm
- profilé "Express Clip" - montage rapide des graphiques
- économique, particulièrement apprécié dans les grandes campagnes publicitaires

Le kit comprend: une cassette roll-up Compact, un mât, un profilé pince-affiche „Express Clip“, un ruban 3M, un sac de transport avec fenêtre pour une carte de visite.

80×200	5907451662762	1,5 kg
85×200	5907451660010	1,56 kg
100×200	5907451660027	1,73 kg

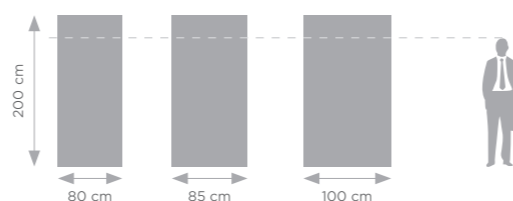

Recommended media and printing technology for this system:



# STANDARD



LONG ZIP BAG

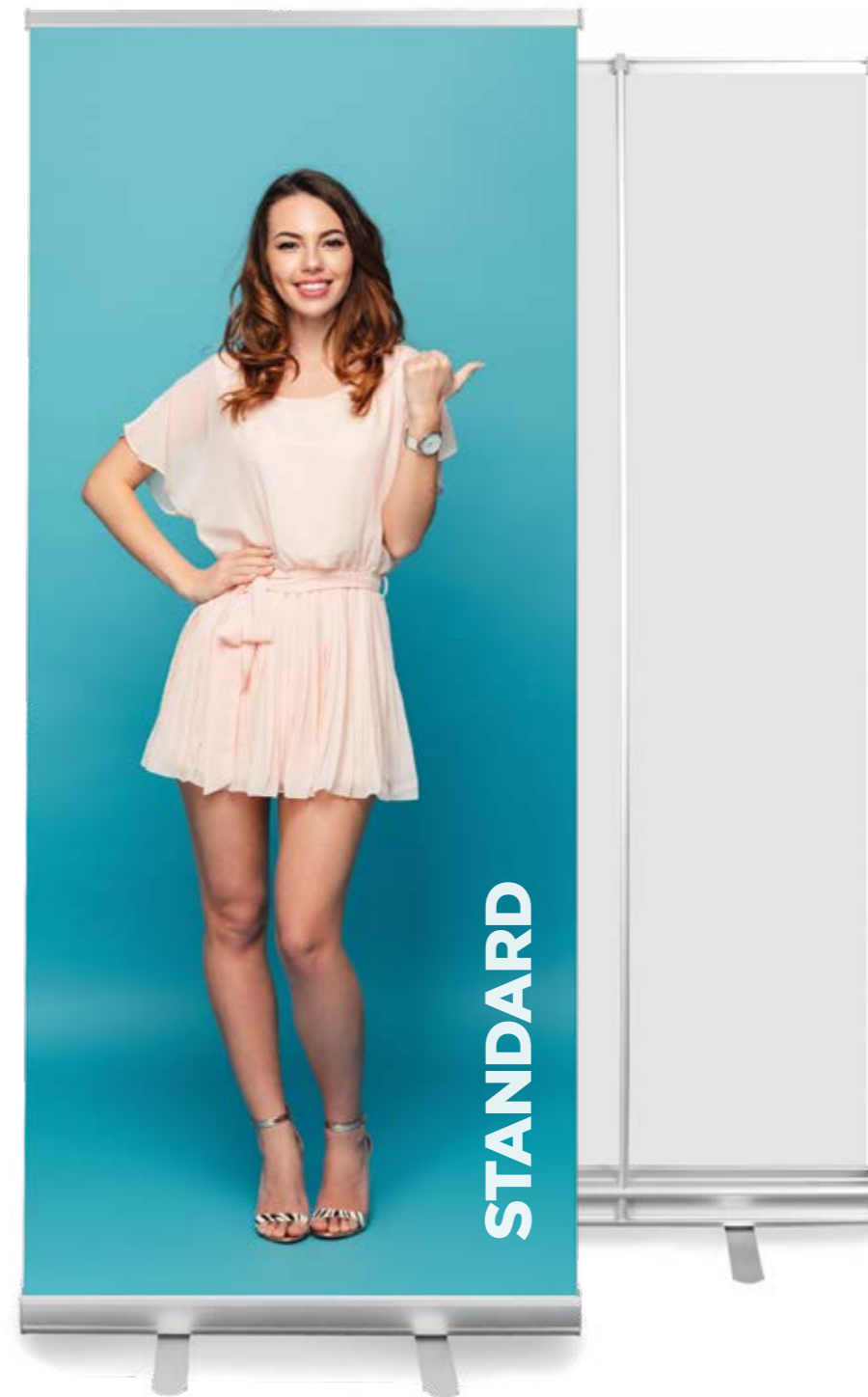

- bestseller on many markets
- stable, strong construction, 100% made of anodized aluminum
- "Express clip" top bar - quick and easy print assembly
- reinforced rear panel with the pole stabilizer
- transport bag with a long zipper

This set includes: Standard roll up cassette, pole (sizes 120×200 and 150×200 include 2 poles), "Express clip" top bar, 3M adhesive tape, bag with a business card pocket, individual box.

- Bestseller in vielen Märkten
- stabile Konstruktion aus 100% eloxiertem Aluminium
- "Express Clip" obere Leiste - schnelle und einfache Druckmontage
- verstärkte Rückwand mit Maststabilisator
- Tasche mit langem Reißverschluss

Dieses Set enthält: Standard Roll-Up-Kassette, Mast (die Größen 120×200 und 150×200 haben zwei Masts), „Express Clip“ - obere Klemmleiste, 3M-Klebeband, Transporttasche mit Fenster für Visitenkarte, Einzelkarton.

- best-seller sur de nombreux marchés
- aluminium anodisé épais et résistant
- panneau arrière renforcé avec le stabilisateur de mât
- profilé „Express Clip“ - montage rapide des graphiques
- sac avec une longue fermeture

Le kit comprend: une cassette roll-up Standard, un mât (es tailles 120×200 et 150×200 comprennent 2 mâts), un profilé pince-affiche „Express Clip“, un ruban 3M, un sac de transport avec fenêtre pour une carte de visite, emballage en carton.

85×200	5907451660034	1,64 kg
100×200	5907451660041	2 kg
120×200	5907451660058	2,4 kg
150×200	5907451660065	3,05 kg

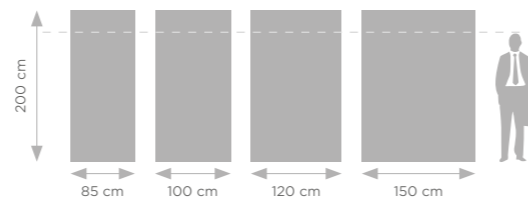

Recommended media and printing technology for this system:



# STANDARD PLUS

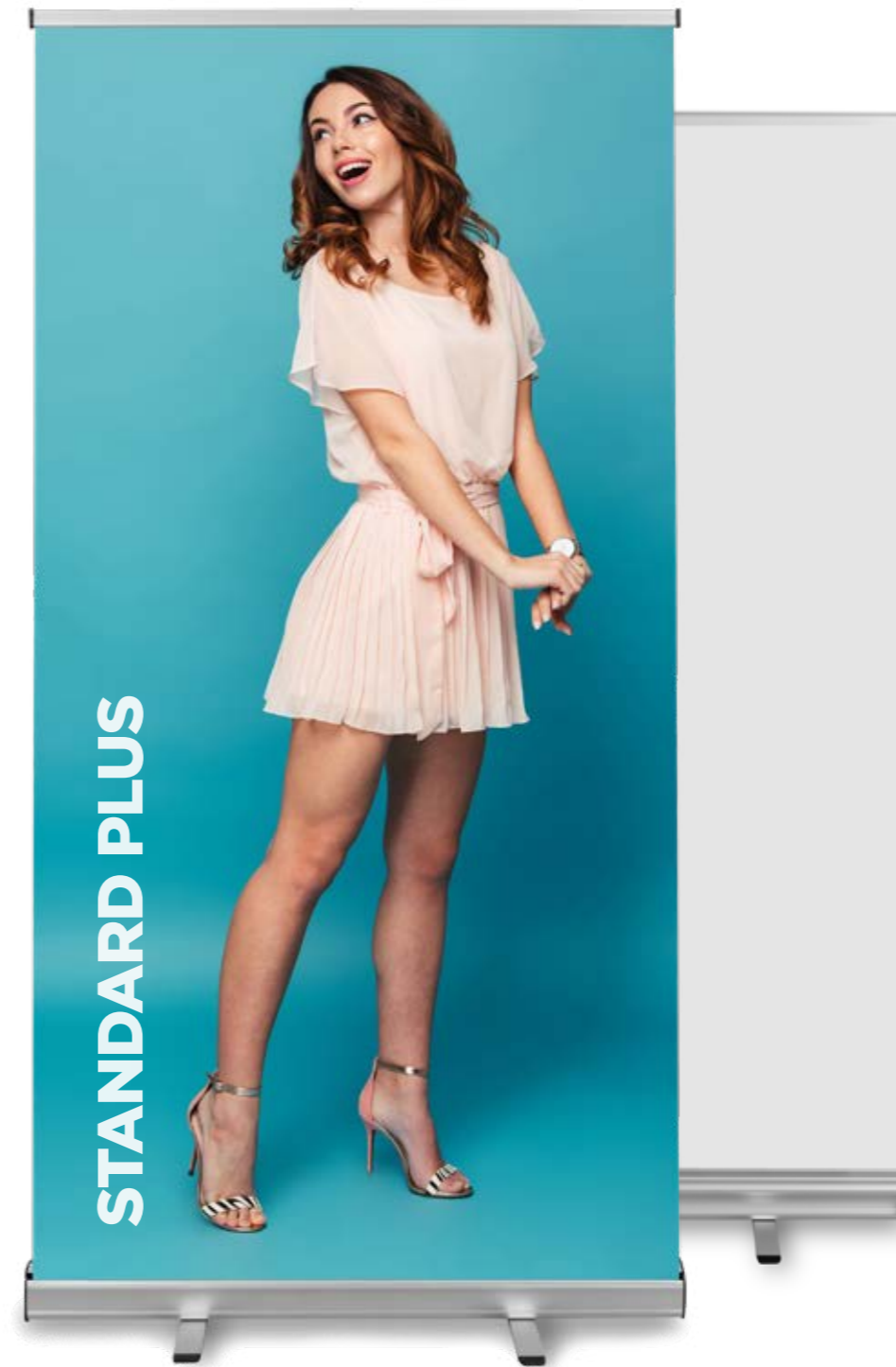

- plastic sides of the cassette, more resistant to dents
- reinforced rear panel with the pole stabilizer
- "Express Clip" top bar – quick and easy print assembly
- transport bag with a long zipper

This set includes: Standard Plus roll up cassette, pole (sizes 120×200 and 150×200 include 2 poles), "Express clip" top bar, 3M adhesive tape, bag with a business card pocket, individual box.

- Seitenwände aus Kunststoff, widerstandsfähiger gegen Dellen
- verstärkte Rückwand mit Maststabilisator
- "Express Clip" obere Leiste – schnelle und einfache Druckmontage
- Tasche mit langem Reißverschluss

Dieses Set enthält: Standard Plus Roll-Up-Kassette, Mast (die Größen 120×200 und 150×200 haben zwei Masten), „Express Clip“ – obere Klemmleiste, 3M-Klebeband, Transporttasche mit Fenster für Visitenkarte, Einzelkarton.

- les côtés en plastique de la cassette, plus résistants aux chocs
- panneau arrière renforcé avec le stabilisateur de mât
- profilé „Express Clip“ – montage rapide des graphiques
- sac avec une longue fermeture

Le kit comprend: une cassette roll-up Standard Plus, un mât (es tailles 120×200 et 150×200 comprennent 2 mâts), un profilé pince-affiche „Express Clip“, un ruban 3M, un sac de transport avec fenêtre pour une carte de visite, emballage en carton.

85×200	5907451662427	1,6 kg
100×200	5907451662434	2 kg
120×200	5907451662724	2,4 kg
150×200	5907451662731	3,05 kg

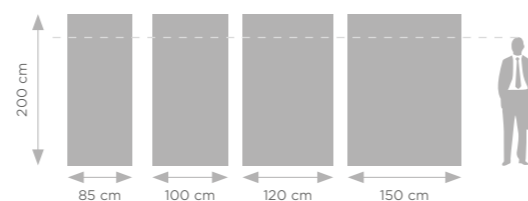

Recommended media and printing technology for this system:



# CLASSIC



LONG ZIP BAG

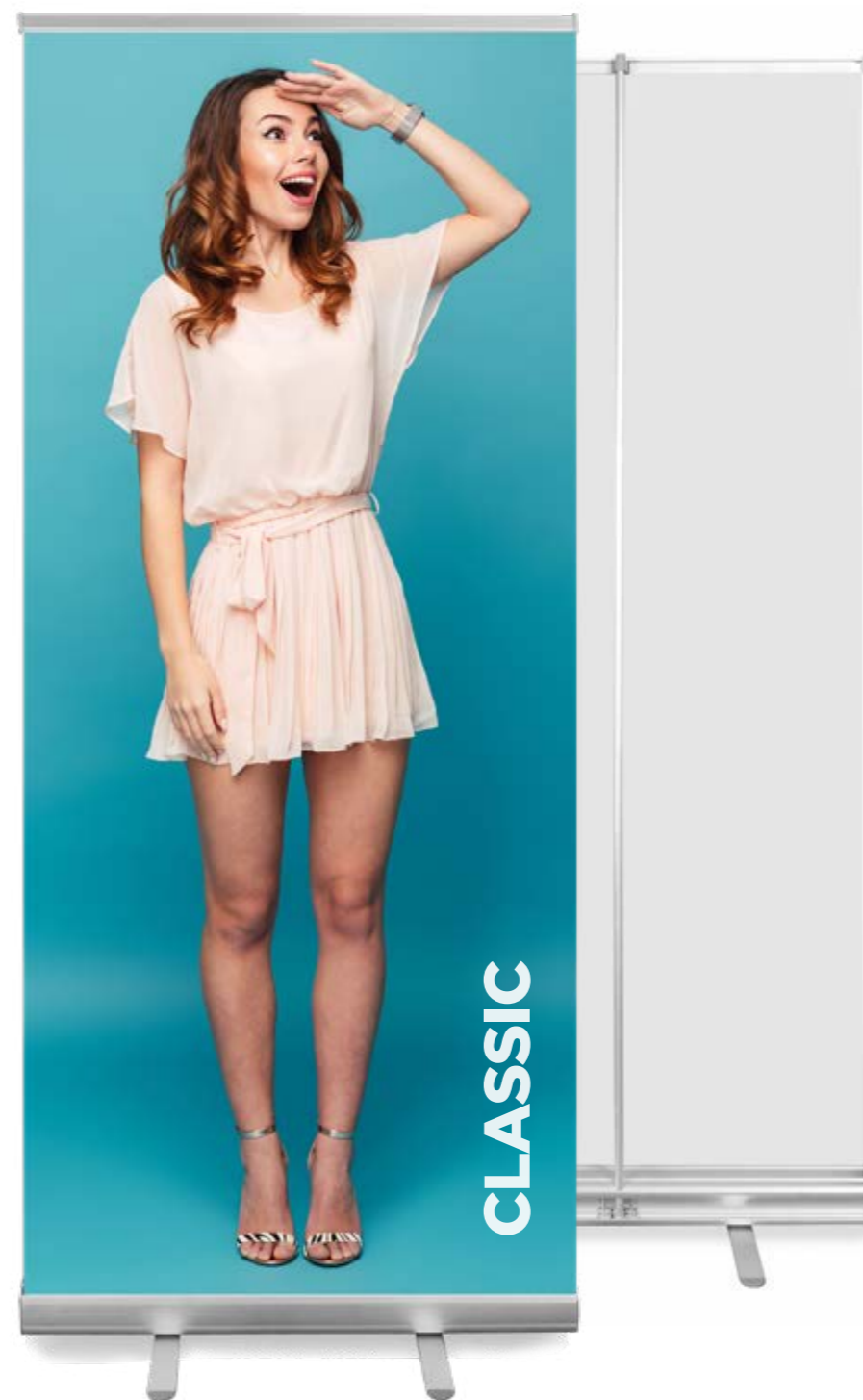

- bestseller on many markets
- reinforced rear panel with the pole stabilizer
- "Express Clip" top bar - quick and easy print assembly
- plastic foot tips
- transport bag with a long zipper

This set includes: Classic roll up cassette, pole (sizes 120x200 and 150x200 include 2 poles), "Express Clip" top bar, 3M adhesive tape, bag with a business card pocket, individual box.

- Bestseller in vielen Märkten
- verstärkte Rückwand mit Maststabilisator
- "Express Clip" obere Leiste - schnelle und einfache Druckmontage
- Plastikfußspitzen
- Tasche mit langem Reißverschluss

Dieses Set enthält: Classic Roll-Up-Kassette, Mast (die Größen 120x200 und 150x200 haben zwei Masten), „Express Clip“ - obere Klemmleiste, 3M-Klebeband, Transporttasche mit Fenster für Visitenkarte, Einzelkarton.

- best-seller sur de nombreux marchés
- panneau arrière renforcé avec le stabilisateur de mât
- profilé „Express Clip“ - montage rapide des graphiques
- embouts de pied en plastique
- sac avec une longue fermeture

Le kit comprend: une cassette roll-up Classic, un mât (es tailles 120x200 et 150x200 comprennent 2 mâts), un profilé pince-affiche „Express Clip“, un ruban 3M, un sac de transport avec fenêtre pour une carte de visite, emballage en carton.

80x200	5907451660638	1,68 kg
85x200	5907451660072	1,8 kg
100x200	5907451660089	1,9 kg
120x200	5907451660096	2,6 kg
150x200	5907451660102	3,4 kg

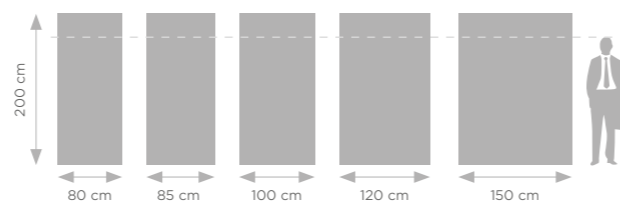

Recommended media and printing technology for this system:



# BASIC

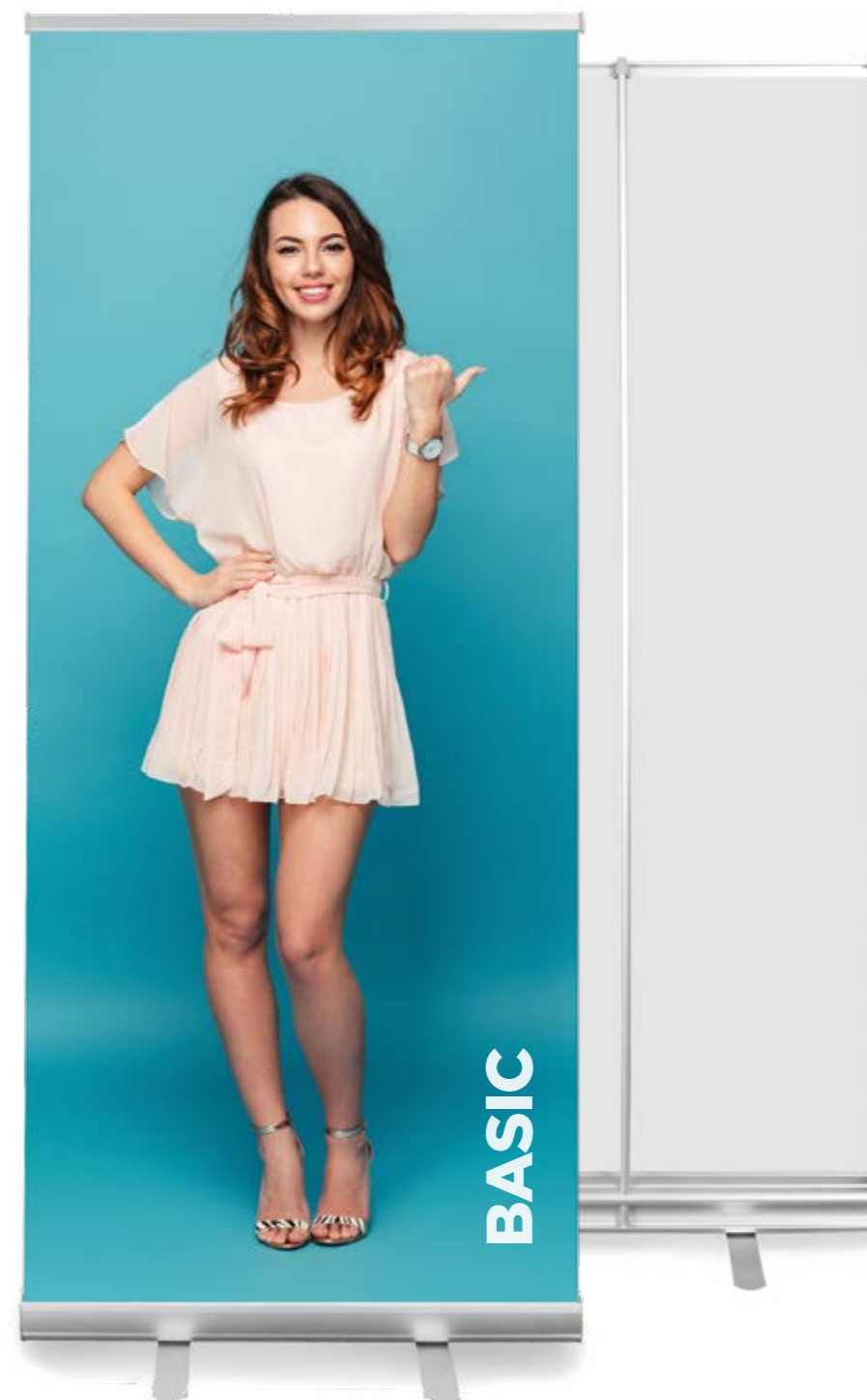

- stable, strong construction, 100% made of anodized aluminum
- the pole stabilizer
- "Express Clip" top bar - quick and easy print assembly
- padded transport bag with a long zipper and trimming

This set includes: Basic roll up cassette, pole (sizes 120x200 and 150x200 include 2 poles), "Express Clip" top bar, 3M adhesive tape, bag with a business card pocket, individual carton box.

- stabile Konstruktion aus 100% eloxiertem Aluminium
- Maststabilisator
- "Express Clip" obere Leiste - schnelle und einfache Druckmontage
- gepolsterte Tasche mit langem Reißverschluss

Dieses Set enthält: Basic Roll-Up-Kassette, Mast (die Größen 120x200 und 150x200 haben zwei Masten), „Express Clip“ - obere Klemmleiste, 3M-Klebeband, Transporttasche mit Fenster für Visitenkarte, Einzelkarton.

- aluminium anodisé épais et résistant
- stabilisateur du mât
- profilé „Express Clip“ - montage rapide des graphiques
- sac renforcé avec une longue fermeture

Le kit comprend: une cassette roll-up Basic, un mât (es tailles 120x200 et 150x200 comprennent 2 mâts), un profilé pince-affiche „Express Clip“, un ruban 3M, un sac de transport avec fenêtre pour une carte de visite, emballage en carton.

80x200	5907451668191	1,9 kg
85x200	5907451668061	2,1 kg
100x200	5907451668078	2,5 kg
120x200	5907451668085	3 kg
150x200	5907451668092	3,7 kg

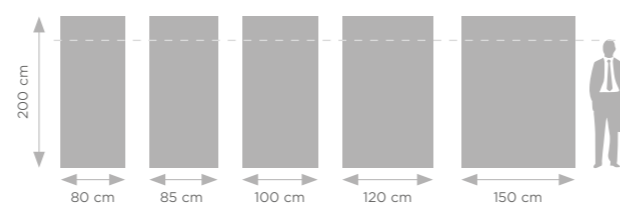

Recommended media and printing technology for this system:



# PREMIUM



LONG ZIP BAG

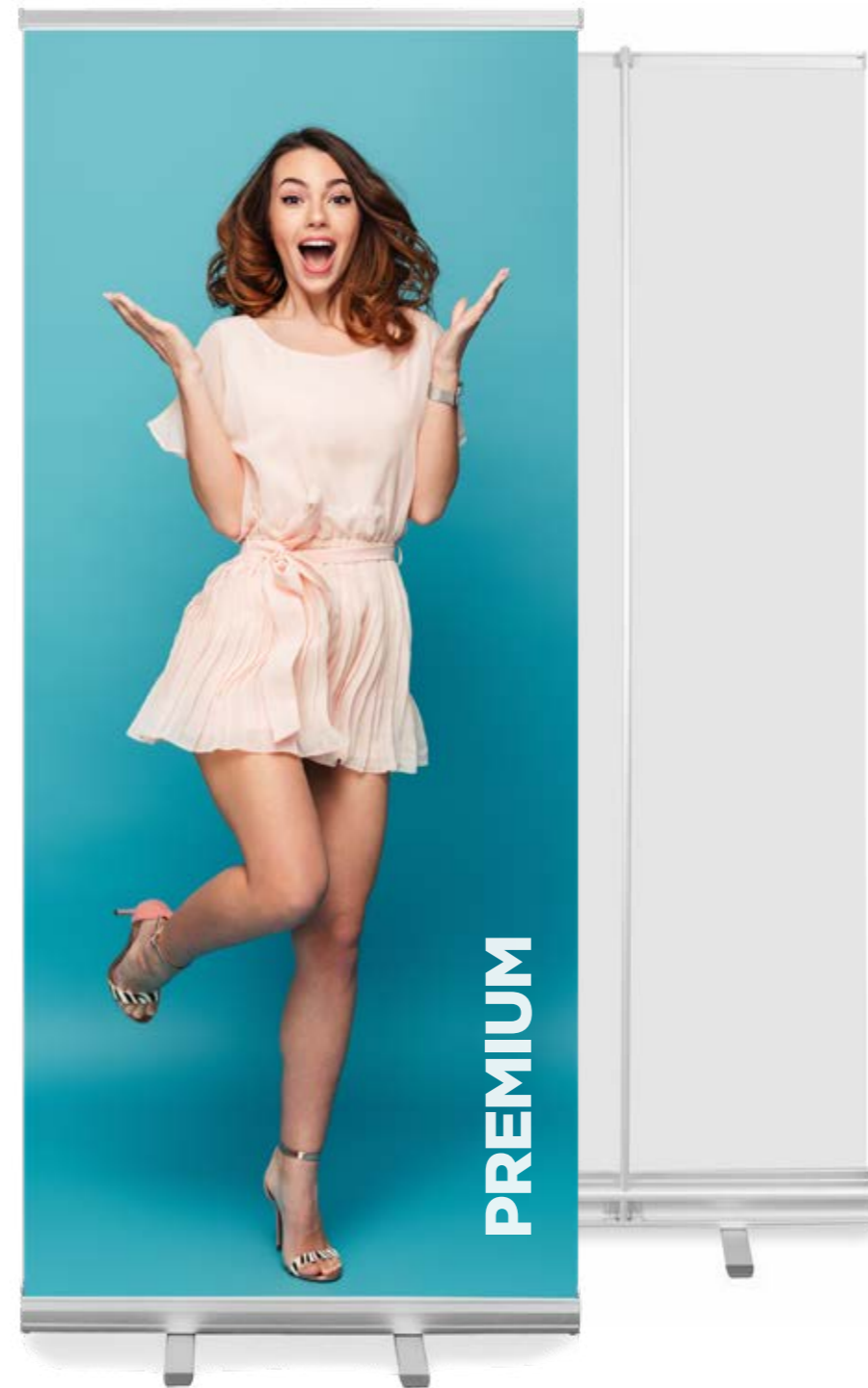

- solid, heavy construction
- reinforced rear panel with the pole stabilizer
- "Express Clip" top bar - quick and easy print assembly
- foot tips and side walls in dark elegant colour
- padded transport bag with a long zipper and trimming

This set includes: Premium roll up cassette, pole (sizes 120×200 and 150×200 include 2 poles), „Express Clip“ top bar, 3M adhesive tape, bag with a business card pocket, individual carton box.

- robuste, schwere Konstruktion
- verstärkte Rückwand mit Maststabilisator
- "Express Clip" obere Leiste - schnelle und einfache Druckmontage
- Seiten und Standfußenden in einer eleganten dunklen Farbe (Anthrazit)
- gepolsterte Tasche mit langem Reißverschluss

Dieses Set enthält: Premium Roll-Up-Kassette, Mast (die Größen 120×200 und 150×200 haben zwei Masten), „Express Clip“ - obere Klemmleiste, 3M-Klebeband, Transporttasche mit Fenster für Visitenkarte, Einzelkarton.

- aluminium anodisé épais et résistant
- panneau arrière renforcé avec le stabilisateur de mât
- profilé „Express Clip“ - montage rapide des graphiques
- pointes de pieds et parois latérales dans une couleur sombre et élégante
- sac renforcé avec une longue fermeture

Le kit comprend: cassette roll-up Premium, un mât (es tailles 120×200 et 150×200 comprennent 2 mâts), un profilé pince-afiche „Express Clip“, un ruban 3M, un sac de transport avec fenêtre pour une carte de visite, emballage en carton.

80×200	5907451668009	2 kg
85×200	5907451660119	2,2 kg
100×200	5907451660126	2,7 kg
120×200	5907451660133	3,5 kg
150×200	5907451660140	4 kg

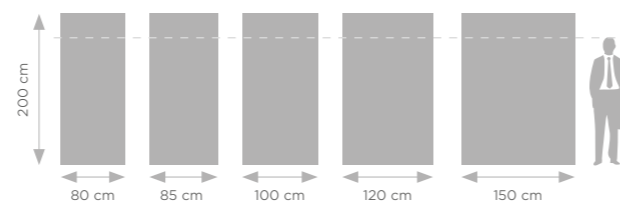

Recommended media and printing technology for this system:



## PRO

**PREMIUM LINE**



LONG ZIP BAG



- 200×200 cm size available
- the thickest aluminium profile among standard cassettes
- heavy and very stable product
- "Express Clip" top bar - quick and easy print assembly
- padded transport bag with a long zipper and trimming

This set includes: Pro roll up cassette, pole (sizes 120×200 and 150×200 include 2 poles, size 200×200 includes 3 poles), "Express Clip" top bar, 3M adhesive tape, bag with a business card pocket, individual box.

- 200×200 cm Größe verfügbar
- dickstes Aluminiumprofil unter den Standardkassetten
- hohes Gewicht und Stabilität des Systems
- "Express Clip" obere Leiste - schnelle und einfache Druckmontage
- gepolsterte Tasche mit langem Reißverschluss

Dieses Set enthält: Pro Roll-Up-Kassette, Mast (die Größen 120×200 und 150×200 haben zwei Masten, 200×200 hat 3 Masten), „Express Clip“ - obere Klemmleiste, 3M-Klebeband, Transporttasche mit Fenster für Visitenkarte, Einzelkarton.

- disponible en taille 200x200 cm
- le profilé aluminium le plus épais disponible dans l'offre
- poids élevé et grande stabilité du système
- profilé „Express Clip“ - montage rapide des graphiques
- sac renforcé avec une longue fermeture

Le kit comprend: cassette roll-up Pro, un mât (es tailles 120×200 et 150×200 comprennent 2 mâts, taille 200×200 comprenant 3 mâts), un profilé pince-affiche „Express Clip“, un ruban 3M, un sac de transport avec fenêtre pour une carte de visite, emballage en carton.

85×200	5907451660584	2,7 kg
100×200	5907451660591	3,1 kg
120×200	5907451660607	3,7 kg
150×200	5907451660614	4,7 kg
200×200	5907451660621	6,2 kg

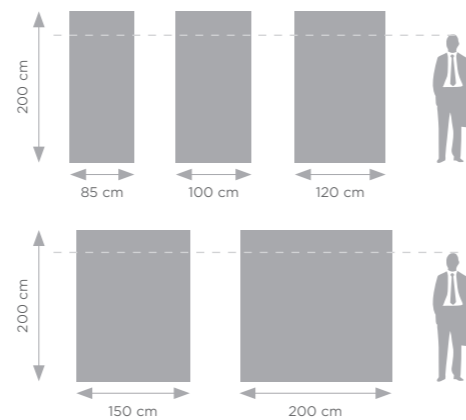

Recommended media and printing technology for this system:



Stoplight  
Solvent, UV, Latex



Coated Frontlit  
Solvent, UV, Latex

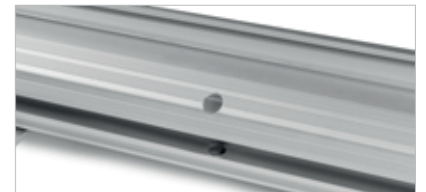
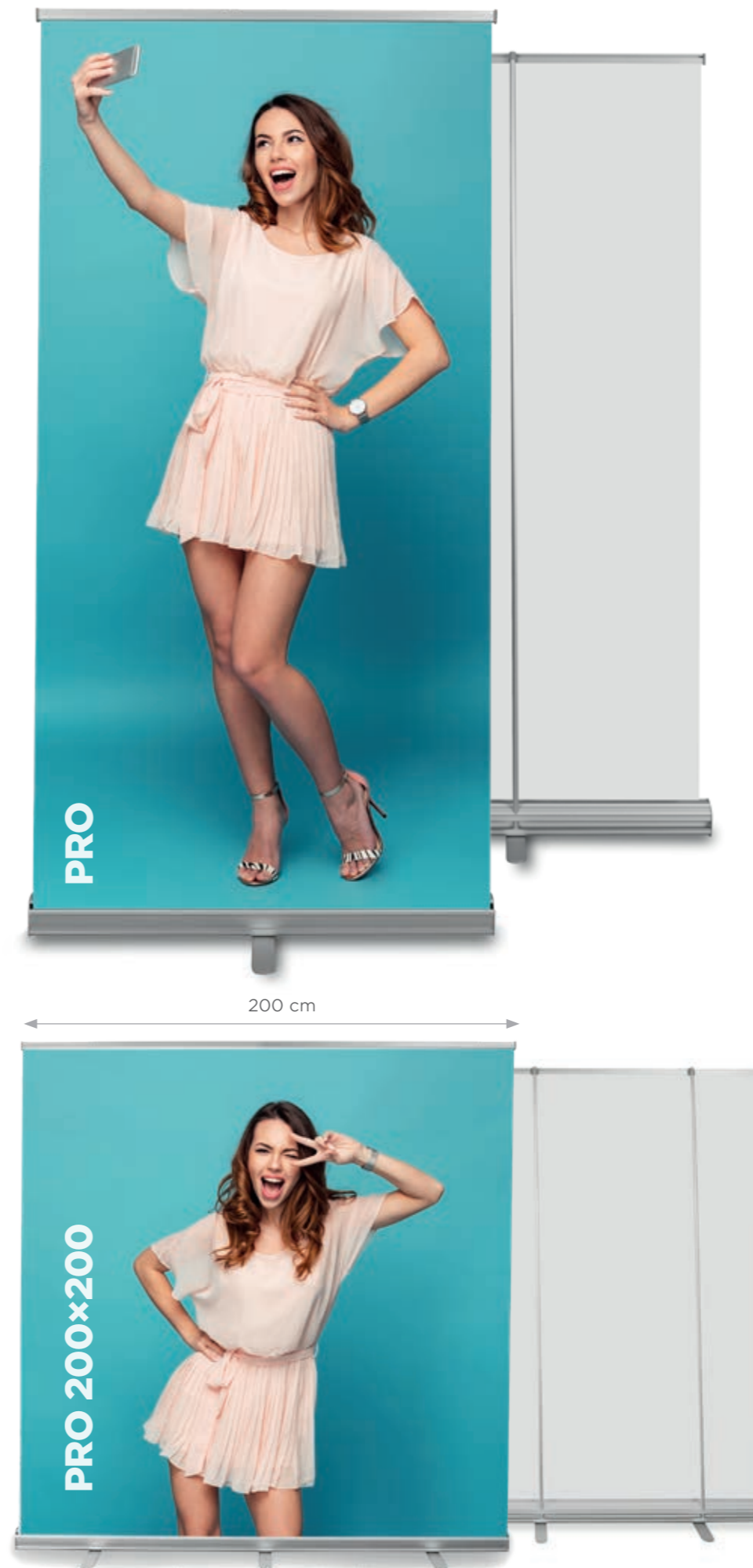



# EXCLUSIVE

PREMIUM LINE

BEST SELLER

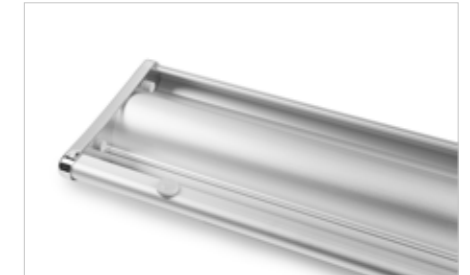
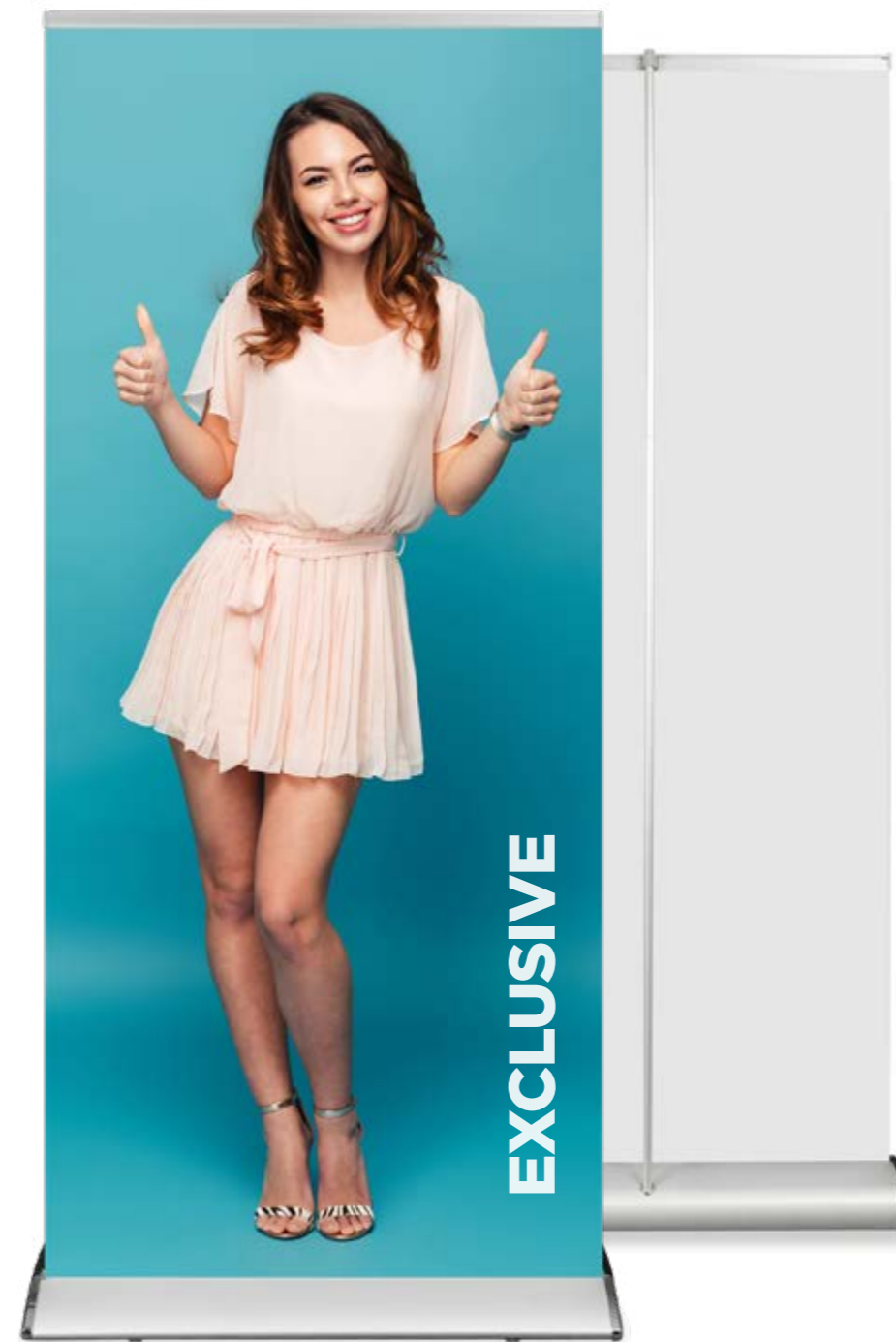

- elegant appearance
- 200x200 cm size available
- heavy and very stable product
- "Express Clip" top bar – quick and easy print assembly
- elegant carrying bag with a long zipper

This set includes: Exclusive roll up cassette, pole (sizes 120x200 and 150x200 include 2 poles, size 200x200 includes 3 poles), "Express Clip" top bar, 3M adhesive tape, bag with a business card pocket, individual box.

- elegantes Aussehen
- 200x200 cm Größe verfügbar
- hohes Gewicht und Stabilität des Systems
- "Express Clip" obere Leiste – schnelle und einfache Druckmontage
- schicke Tasche mit langem Reißverschluss

Dieses Set enthält: Exclusive Roll-Up-Kassette, Mast (die Größen 120x200 und 150x200 haben zwei Masten, 200x200 hat 3 Masten), „Express Clip“ – obere Klemmleiste, 3M-Klebeband, Transporttasche mit Fenster für Visitenkarte, Einzelkarton.

- aspect élégant et design unique
- disponible en taille 200x200 cm
- la construction la plus stable parmi les bannières roll-up
- profilé „Express Clip“ - montage rapide des graphiques
- sac avec une longue fermeture

Le kit comprend: une cassette roll-up Exclusive, un mât (es tailles 120x200 et 150x200 comprennent 2 mâts, taille 200x200 comprenant 3 mâts), un profilé pince-affiche „Express Clip“, un ruban 3M, un sac de transport avec fenêtre pour une carte de visite, emballage en carton.

85x200	5907451660492	2,7 kg
100x200	5907451660508	3,2 kg
120x200	5907451660515	3,8 kg
150x200	5907451660522	4,8 kg
200x200	5907451660539	6,4 kg

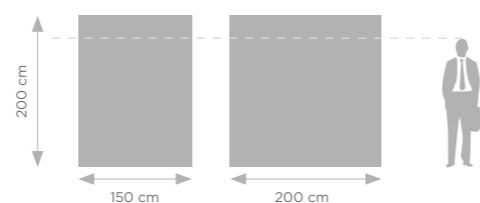
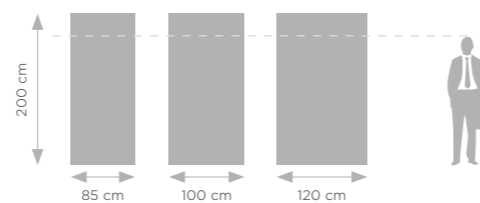

Recommended media and printing technology for this system:



# EXCLUSIVE BLACK

NEW!

PREMIUM LINE

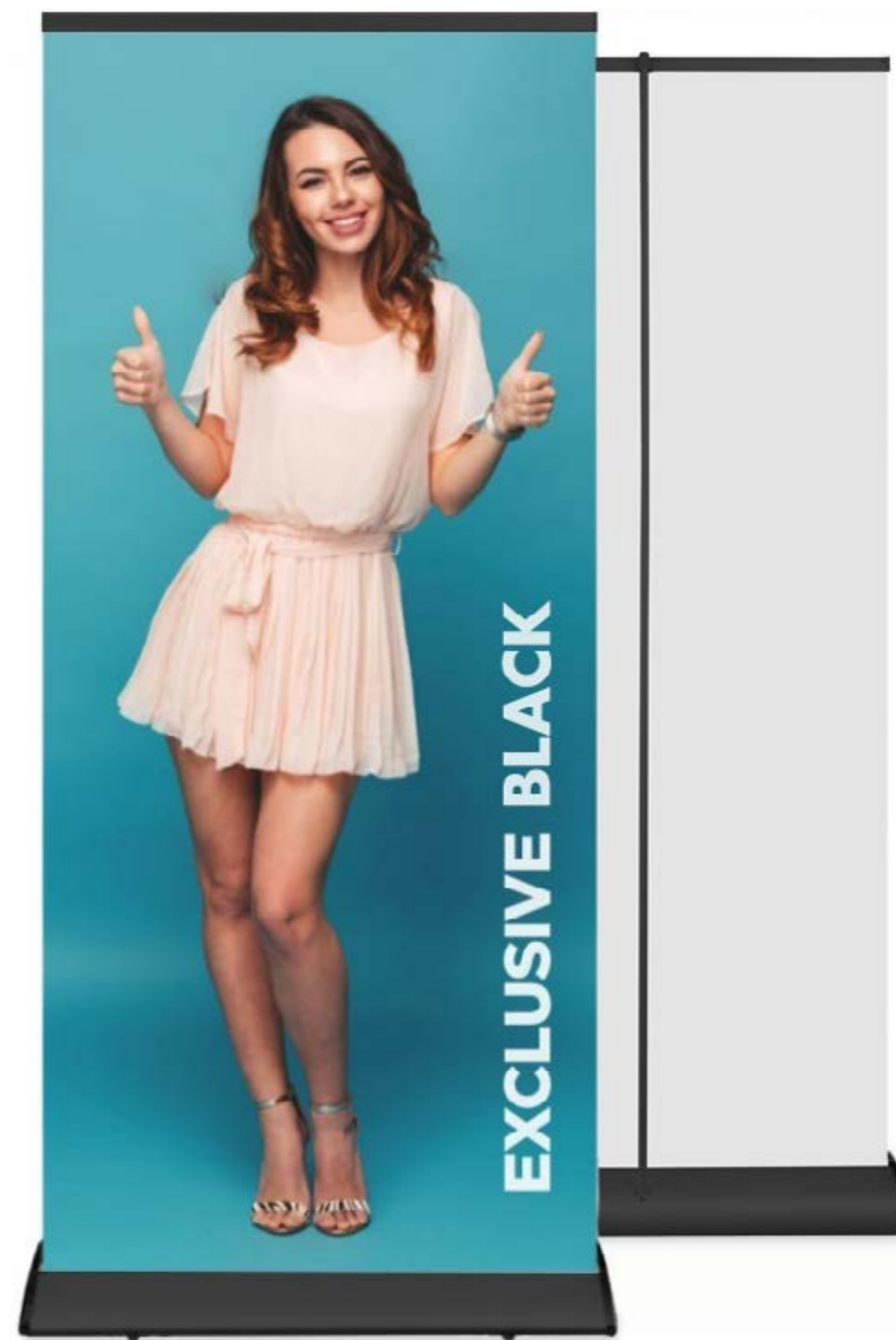

- elegant appearance
- heavy and very stable product
- "Express Clip" top bar - quick and easy print assembly
- elegant carrying bag with a long zipper

This set includes: Exclusive roll up cassette, pole, "Express Clip" top bar, 3M adhesive tape, bag with a business card pocket, individual box.

- elegantes Aussehen
- hohes Gewicht und Stabilität des Systems
- "Express Clip" obere Leiste - schnelle und einfache Druckmontage
- schicke Tasche mit langem Reißverschluss

Dieses Set enthält: Exclusive Roll-Up-Kassette, Mast, „Express Clip“ - obere Klemmleiste, 3M-Klebeband, Transporttasche mit Fenster für Visitenkarte, Einzelkarton.

- aspect élégant et design unique
- la construction la plus stable parmi les bannières roll-up
- profilé „Express Clip“ - montage rapide des graphiques
- sac avec une longue fermeture

Le kit comprend: une cassette roll-up Exclusive, un mât, un profilé pince-affiche „Express Clip“, un ruban 3M, un sac de transport avec fenêtre pour une carte de visite, emballage en carton.

85x200	5907451666982	2,7 kg
100x200	5907451666975	3,2 kg

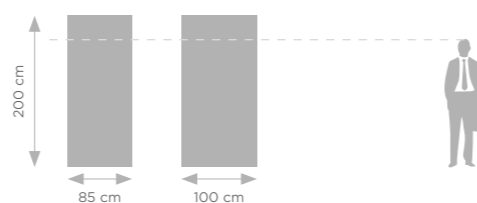

Recommended media and printing technology for this system:



# WAVE

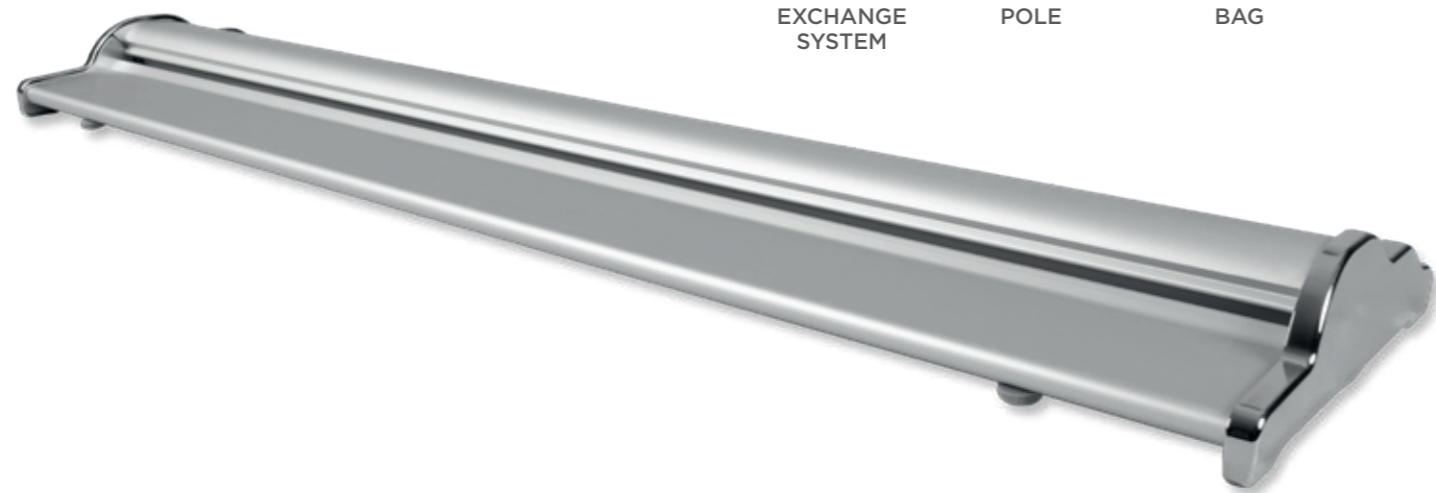

-   
**GRAPHICS EXCHANGE SYSTEM**
-   
**TELESCOPIC POLE**
-   
**LONG ZIP BAG**

- adjustable pole (up to 220 cm)
- graphics exchange system
- elegant, stylish look
- "Express Clip" top bar - quick and easy print assembly
- padded bag with a long zipper



This set includes: WAVE roll up cassette, pole (sizes 120×200 and 150×200 include 2 poles, size 200×200 includes 3 poles), "Express Clip" top bar, graphics exchange system, padded bag with a business card pocket, individual box.

- höhenverstellbar bis zu 220 cm
- Grafik-Austausch-System
- elegantes, außergewöhnliches Design
- "Express Clip" obere Leiste - schnelle und einfache Druckmontage
- gepolsterte, elegante Tasche mit langem Reißverschluss

Dieses Set enthält: WAVE Roll-Up-Kassette, Mast (die Größen 120×200 und 150×200 haben zwei Masten, 200×200 hat 3 Masten), „Express Clip“ - obere Klemmleiste, Grafik-Austausch-System, Transporttasche mit Fenster für Visitenkarte, Einzelkarton.

- mât réglable jusqu'à 220 cm
- système permettant d'échanger les images
- aspect élégant et insolite
- profilé „Express Clip“ - montage rapide des graphiques
- sac deux épaisseurs avec une longue fermeture

Le kit comprend: une cassette roll-up Wave, un mât (es tailles 120×200 et 150×200 comprennent 2 mâts, taille 200×200 comprenant 3 mâts), un profilé pince-affiche „Express Clip“, système permettant d'échanger les images, un sac de transport avec fenêtre pour une carte de visite, emballage en carton.

		
85×200	5907451665831	2,6 kg
100×200	5907451665848	3,1 kg
120×200	5907451665855	6,2 kg
150×200	5907451665862	7 kg
200×200	5907451665879	7,5 kg

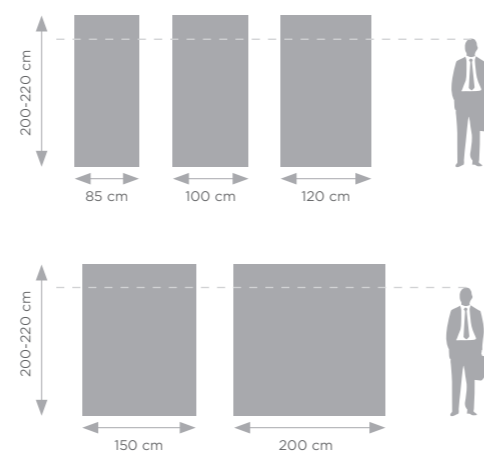

Recommended media and printing technology for this system:

-   
**Stoplight**  
 Solvent, UV, Latex
-   
**Coated Frontlit**  
 Solvent, UV, Latex



# TWIN



- two-sided roll up model: two separate printouts
- heavy and very stable product
- "Express Clip" top bar – quick and easy print assembly

This set includes: Twin roll up cassette, pole, "Express Clip" top bar, 3M adhesive tape, bag with a business card pocket, individual box.

- doppelseitiges Modell: hat zwei Ausdrücke
- hohes Gewicht und Stabilität des Systems
- "Express Clip" obere Leiste – schnelle und einfache Druckmontage

Dieses Set enthält: Twin Roll-Up-Kassette, Mast, „Express Clip“ – obere Klemmleiste, 3M-Klebeband, Transporttasche mit Fenster für Visitenkarte, Einzelkarton.

- présentation des visuels sur les deux faces
- structure stable, cassette très lourde
- profilé „Express Clip“ – montage rapide des graphiques

Le kit comprend: une cassette roll-up Twin, un mât, un profilé pince-affiche „Express Clip“, un ruban 3M, un sac de transport avec fenêtre pour une carte de visite, emballage en carton.

85x200	5907451660645	4 kg
100x200	5907451660652	4,7 kg

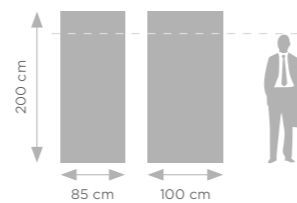

Recommended media and printing technology for this system:



# STANDARD BLACK



LONG ZIP BAG

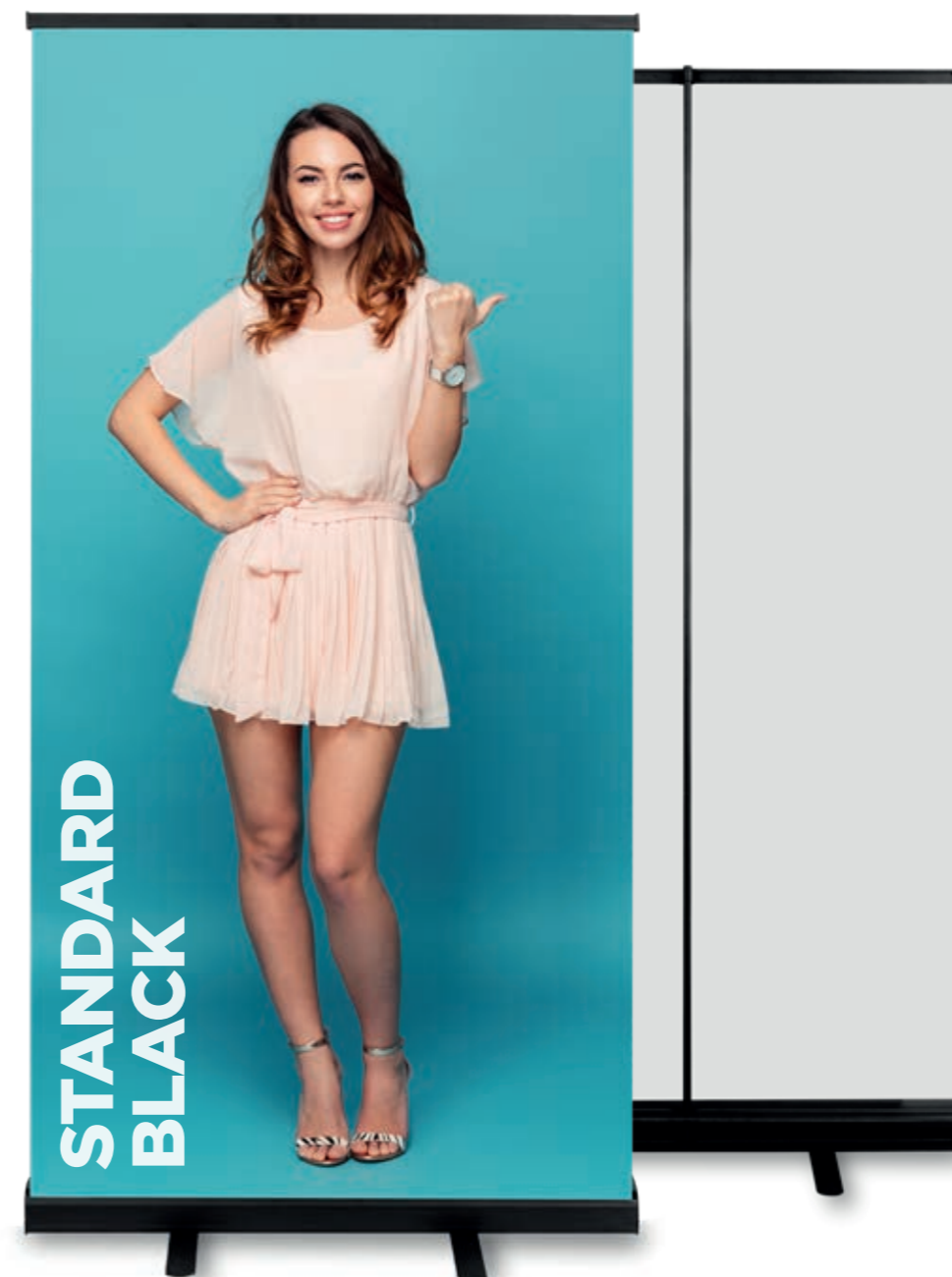

- powder painted black (mat)
- stable, strong construction, 100% made of anodized aluminum
- the pole stabilizer
- "Express clip" top bar – quick and easy print assembly
- transport bag with a long zipper

This set includes: Standard Black roll up cassette, pole, "Express clip" top bar, 3M adhesive tape, bag with a business card pocket, individual box.

- matte schwarze Farbe
- stabile Konstruktion aus 100% eloxiertem Aluminium
- Maststabilisator
- "Express Clip" obere Leiste – schnelle und einfache Druckmontage
- Tasche mit langem Reißverschluss

Dieses Set enthält: Standard Black Roll-Up-Kassette, Mast, „Express Clip“ – obere Klemmleiste, 3M-Klebeband, Transporttasche mit Fenster für Visitenkarte, Einzelkarton.

- cassette noire (peinture en poudre)
- construction éprouvée et stable
- aluminium anodisé épais et résistant
- stabilisateur du mât
- profilé „Express Clip“ – montage rapide des graphiques
- sac avec une longue fermeture

Le kit comprend: une cassette roll-up Standard Black, un mât, un profilé pince-affiche „Express Clip“, un ruban 3M, un sac de transport avec fenêtre pour une carte de visite, emballage en carton.

85x200	5907451662472	1,60 kg
100x200	5907451662700	1,90 kg

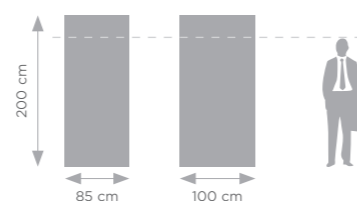

Recommended media and printing technology for this system:



## ROLL UP ACCESSORIES

### ROLL UP LIGHT

🇬🇧 If you need to illuminate the printout, our lamps, mounted directly on the roll-up pole, will be a perfect solution. Two variants are available: in LED and halogen technology. They will definitely improve the aesthetics of graphics.

🇩🇪 Wenn Sie den Druck beleuchten müssen, sind unsere Lampen, die direkt auf Roll up montiert sind, eine perfekte Lösung. Zwei Varianten stehen zur Verfügung: in LED - und Halogentechnik. Sie werden definitiv die Ästhetik von Grafiken verbessern.

🇫🇷 Si vous avez besoin d'éclairer votre impression, nos lampes, montées directement sur le mât des bannières roll-up, sont idéales. Deux variantes sont disponibles: LED et halogène. Elles amélioreront sans aucun doute l'esthétique et la perception du graphisme.

#### HALOGEN



5907451669945 0,3 kg

#### LED

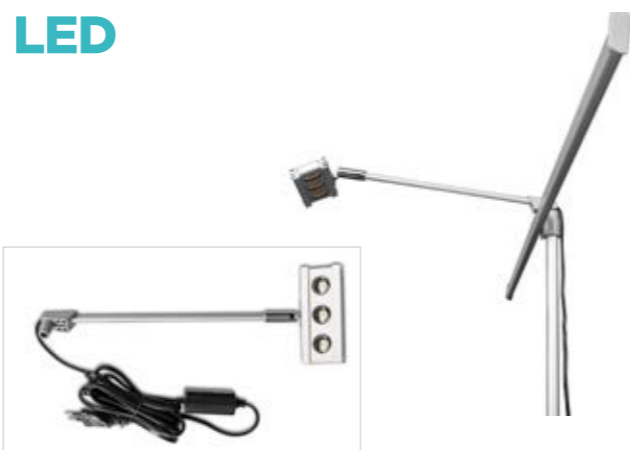

5907451669938 0,3 kg

### BLOCKOUTS



- high class materials
- materials do not let light through
- opaque surface prevents unwanted reflexes
- high density and thickness

- Hochwertige Materialien
- Materialien lassen kein Licht durch
- undurchsichtige Oberfläche verhindert unerwünschte Reflexe
- hohe Dichte und Dicke

- matériaux de haute qualité
- les matériaux ne laissent pas passer la lumière
- la surface opaque empêche les reflets indésirables
- densité et épaisseur élevées

	Width (m)	Barcode
Premium 330 g	0,914	5907451663219
Premium 330 g	1,07	5907451663226
Premium 330 g	1,27	5907451663233
Premium 330 g	1,52	5907451663240
Premium B1 FR (flame retardant) 330 g	0,914	5907451667316
Premium B1 FR (flame retardant) 330 g	1,07	5907451667323
Premium B1 FR (flame retardant) 330 g	1,27	5907451667293
PVC Free 300 g	0,914	5907451663257
PVC Free 300 g	1,07	5907451667309



# STANDS

## X-BANNER COMPACT

- low cost system
- simple handling
- ultralight construction made of fiberglass

This set includes: complete X-banner system and a simple bag.

- ein billiges System
- einfache Bedienung
- ultraleichte Fiberglaskonstruktion

Dieses Set enthält: ein komplettes X-Banner-System, eine einfache Tasche.

- coût du système très faible
- construction ultralégère en fibre de verre
- montage simple

Le kit comprend: un système X-banner Compact, un sac en polyester.

Size	Barcode	Weight
60x160	5907451660195	0,6 kg
80x180	5907451660201	0,8 kg

Recommended media and printing technology for this system:

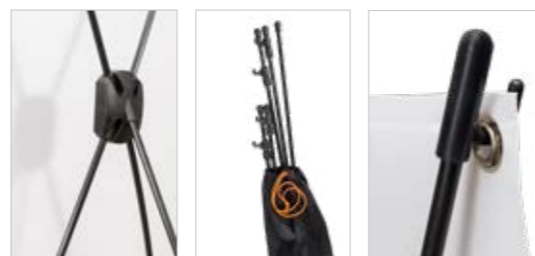
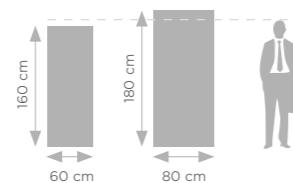

## X-BANNER STANDARD

- improved model of X-banner system
- construction made of metal painted in black and fiberglass
- high quality
- ultralight, easy to carry and use

This set includes: complete X-banner system and a bag (the print-out also can fit in).

- höheres X-Banner-Systemmodell
- schwarze pulverbeschichtete Metall und Fiberglaskonstruktion
- hochwertige Verarbeitung
- ultra-leicht und einfach zu bedienen

Dieses Set enthält: Ein komplettes X-Banner-System, eine Tasche, in die auch ein Ausdruck past.

- modèle amélioré du système de bannière X (effectué en métal thermolaqué noir et il possède des bras flexibles en fibre de verre)
- construction ultralégère
- montage simple
- haute qualité des produits

Le kit comprend: un système X-banner Standard, un sac de transport (l'impression peut également tenir dans).

Size	Barcode	Weight
60x160	5907451660218	1,3 kg
80x180	5907451660225	1,4 kg
120x210	5907451660232	1,7 kg

Recommended media and printing technology for this system:

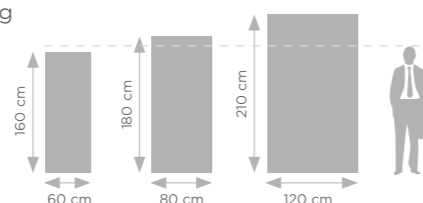

## L-BANNER

- low cost system
- simple handling
- ultralight
- single and double sided version available

These sets include: complete L-banner system and a simple bag (the printout also can fit in).

- ein billiges System
- ultraleicht
- einfach zu bedienen
- einzel und doppelseitige Version erhältlich

Dieses Set enthält: Ein komplettes L-Banner-System, eine Tasche, in die auch ein Ausdruck past.

- coût du système très faible
- construction ultralégère
- montage simple
- version simple et double face disponible

Le kit comprend: un système L-banner, un sac de transport (l'impression peut également tenir dans).

Recommended media and printing technology for this systems:



## L-BANNER PREMIUM



Size	Barcode	Weight
85x210	5907451660669	1,4 kg

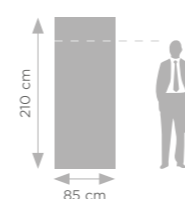

## L-BANNER PREMIUM TWIN



Size	Barcode	Weight
85x210	5907451660683	2,40 kg
100x210	5907451660690	2,70 kg

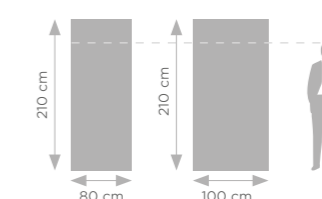

# ATLANTIS EXPO

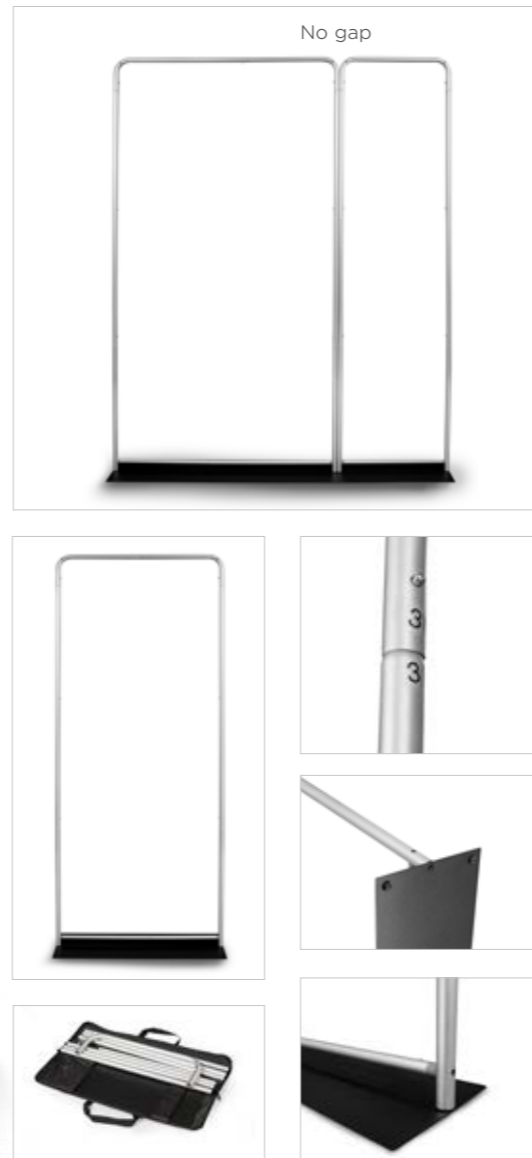

- base made of metal plate
- **very stable construction (profile - Ø 25 mm)**
- value for money
- simple handling
- double-sided system

This set includes: complete Expo system and a bag (the printout also can fit in).

- Metallplatte Basis
- **sehr stabile Konstruktion (Profilbreite - Ø 25 mm)**
- sehr niedrige Systemkosten
- einfache Bedienung
- doppelseitig

Dieses Set enthält: ein komplettes Expo System, eine Tasche, in die auch ein Ausdruck past.

- **profilé aluminium du système (Ø 25 mm)**
- les pieds ont été remplacés par une plaque métallique
- faible coût du système
- image recto-verso
- montage simple et rapide

Le kit comprend: un système Atlantis Expo, un sac de transport (l'impression peut également tenir dans).

60x230	5907451660409	4,30 kg
90x230	5907451660416	5,60 kg
120x230	5907451660423	8,00 kg
150x230	5907451660430	9,70 kg

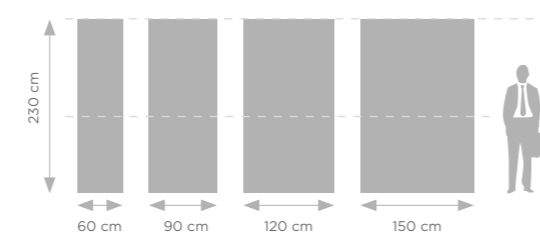

Recommended media and printing technology for this system:

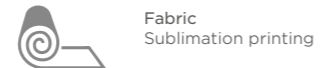

ADVERTISING WALLS



# MEGA SEG™ SYSTEM



  
PRE-ASSEMBLED  
CONSTRUCTION

  
ULTRALIGHT  
SYSTEM

  
MODULAR  
EXPANSION  
OPTION

  
NO TOOLS

  
DOUBLE SIDED

  
SILICONE TAPE  
MOUNTED  
PRINTOUT

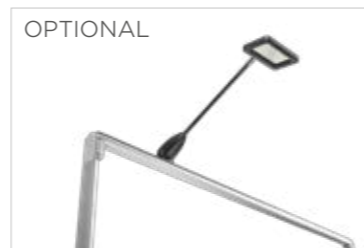

- ultralight, double-sided, modular system
- **pre-assembled hinge-based construction = express unfolding**
- aluminium frame (4,2 cm)
- no tools assembly
- graphics mounted with silicone tape
- **several walls - one printout!**

The set includes: MEGA SEG system, a set of connectors (parallel - 4 pieces, top - 1 piece, bottom - 1 piece), transport bag.

- ultraleichtes, doppelseitiges, modulares System
- **vormontierte scharnierbasiertes Design = schnelles Entfaltungssystem**
- Aluminiumrahmen (4,2 cm)
- Montage ohne Werkzeug
- Silikonband montiert Ausdruck
- **mehrere Wände - ein Druck!**

Das Set enthält: MEGA SEG-System, Verbindungssatz (Serie - 4 Stück, oben - 1 Stück, unten - 1 Stück), Transporttasche.

- **pre-assemblée conception basée sur des charnières = système de dépliage rapide**
- système modulaire ultraléger, double face
- montage sans outils
- cadre en aluminium (4,2 cm)
- l'image montée à l'aide d'une bande silicone
- **plusieurs panneaux - une seule impression!**

Le kit comprend: un système MEGA SEG™, un jeu de connecteurs (série - 4 pièces, supérieur - 1 pièce, inférieur - 1 pièce), un sac de transport.

MEGA SEG SYSTEMS ARE DISTINGUISHED BY ITS PRE-ASSEMBLED DESIGN, WHICH SIMPLY NEEDS TO BE OPENED.

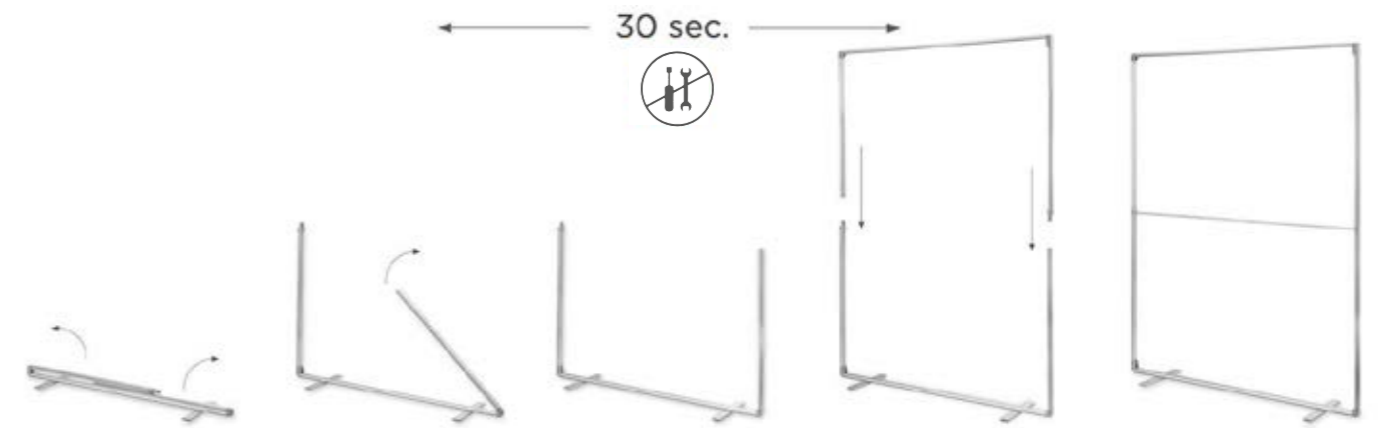

MEGA SEG SYSTEMS CAN BE CONNECTED TOGETHER USING SPECIAL CONNECTORS. THIS OFFERS ALMOST UNLIMITED POSSIBILITIES OF CREATING DIFFERENT SYSTEMS. CONNECTING THE PRODUCTS IN PARALLEL ALLOWS A SINGLE PRINT TO BE APPLIED, WITH NO VISIBLE GAPS BETWEEN THE SYSTEMS.

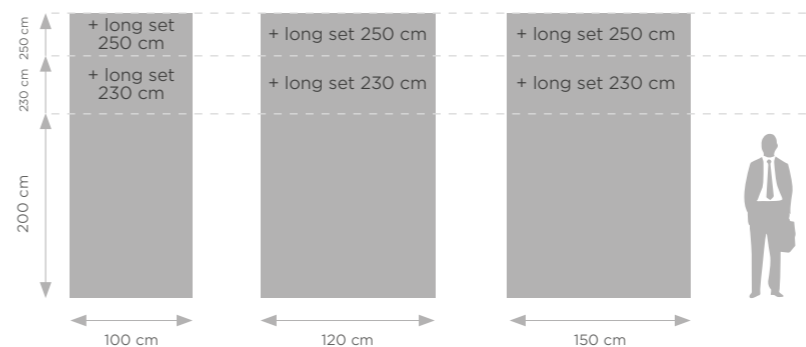

		
100x200	5907451668948	2,1 kg
120x200	5907451668931	2,6 kg
150x200	5907451668924	3,2 kg

Recommended media and printing technology for this system:

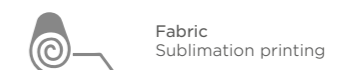

The Long Sets increase the height of the product up to 230 or 250 cm.

# POP-UP STRAIGHT



- UK
  - the best value for money
  - "pop up" mechanism - express unfolding
  - interchangeable briches

This set includes: Pop-up frame, set of construction bars, set of upper 3M magnetic bars, 3M magnetic tape, set of PVC boards.
- DE
  - das beste Preis-Leistungs-Verhältnis
  - „Pop-Up“-Mechanismus - sofortiges Falten der Wand
  - austauschbaren Lamellen

Dieses Set enthält: Pop-up Wand, ein Satz Konstruktions Bügeln, ein Satz 3M Befestigungsstreifen für Paneelen Montage, 3M magnetische Band, ein Satz Paneele.
- FR
  - prix bas/haute qualité
  - système „pop up“ - montage rapide
  - panneaux interchangeables

Le kit comprend: un cadre Pop-Up, des barres de fixation pour les panneaux avec du ruban 3M, un jeu de barres de construction, une bande magnétique 3M et un jeu de panneaux avant et latéraux.

3x3 (in trolley case)	5907451660317	24 kg
3x3 (in counter case)	5907451666081	24 kg
3x4 (in trolley case)	5907451660324	28 kg
3x4 (in counter case)	5907451666098	28 kg

Case counter and trolley bag - page 66

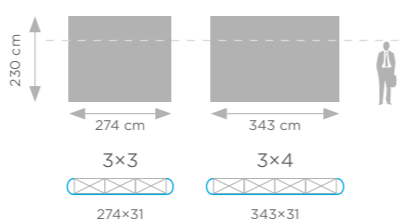

Recommended media and printing technology for this system:



# POP-UP ARC



- UK
  - the best value for money
  - "pop up" mechanism - express unfolding
  - interchangeable briches

This set includes: Pop-up frame, set of construction bars, set of upper 3M magnetic bars, 3M magnetic tape, set of PVC boards.
- DE
  - das beste Preis-Leistungs-Verhältnis
  - „Pop-Up“-Mechanismus - sofortiges Falten der Wand
  - austauschbaren Lamellen

Dieses Set enthält: Pop-up Wand, ein Satz Konstruktions Bügeln, ein Satz 3M Befestigungsstreifen für Paneelen Montage, 3M magnetische Band, ein Satz Paneele.
- FR
  - prix bas/haute qualité
  - système „pop up“ - montage rapide
  - panneaux interchangeables

Le kit comprend: un cadre Pop-Up, des barres de fixation pour les panneaux avec du ruban 3M, un jeu de barres de construction, une bande magnétique 3M et un jeu de panneaux avant et latéraux.

3x3 (in trolley case)	5907451660331	24 kg
3x3 (in counter case)	5907451666104	24 kg
3x4 (in trolley case)	5907451660348	28 kg
3x4 (in counter case)	5907451666111	28 kg

Case counter and trolley bag - page 66

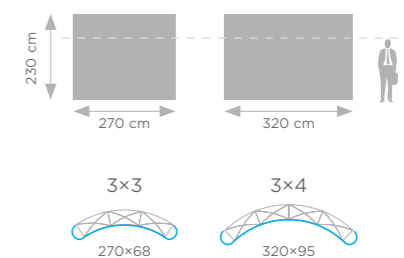

Recommended media and printing technology for this system:



# STANDARD MAGNETIC POP-UP STRAIGHT



- special system of fast assembling element using built-in magnets
- "pop up" mechanism - express unfolding
- interchangeable bristles

This set includes: Standard Magnetic Pop-up frame, set of magnetic construction bars, set of upper 3M magnetic bars, 3M magnetic tape, set of PVC boards.

- Schnellkupplungssystem von Komponenten mit integrierten Magneten
- „Pop-Up“-Mechanismus - sofortiges Falten der Wand
- austauschbaren Lamellen

Dieses Set enthält: Standard Magnetic Pop-up Wand, ein Satz Konstruktions Bügeln (magnetisch), ein Satz 3M Befestigungsstreifen für Paneelen Montage, 3M magnetische Band, ein Satz Paneele.

- système „pop up“ - montage rapide
- système spécial d'assemblage rapide d'un élément à l'aide d'aimants intégrés
- panneaux interchangeables

Le kit comprend: un cadre Standard Magnetic Pop-Up, des barres de fixation pour les panneaux avec du ruban 3M, un jeu de barres de construction, une bande magnétique 3M et un jeu de panneaux avant et latéraux.

3x3 (in trolley case)	5907451661024	22 kg
3x3 (in case counter)	5907451665985	22 kg
3x4 (in trolley case)	5907451661031	26 kg

Case counter and trolley bag - page 66

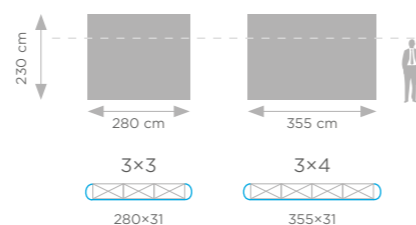

Recommended media and printing technology for this system:



# STANDARD MAGNETIC POP-UP ARC



- special system of fast assembling element using built-in magnets
- "pop up" mechanism - express unfolding
- interchangeable bristles

This set includes: Standard Magnetic Pop-up frame, set of magnetic construction bars, set of upper 3M magnetic bars, 3M magnetic tape, set of PVC boards.

- Schnellkupplungssystem von Komponenten mit integrierten Magneten
- „Pop-Up“-Mechanismus - sofortiges Falten der Wand
- austauschbaren Lamellen

Dieses Set enthält: Standard Magnetic Pop-up Wand, ein Satz Konstruktions Bügeln (magnetisch), ein Satz 3M Befestigungsstreifen für Paneelen Montage, 3M magnetische Band, ein Satz Paneele.

- système „pop up“ - montage rapide
- système spécial d'assemblage rapide d'un élément à l'aide d'aimants intégrés
- panneaux interchangeables

Le kit comprend: un cadre Standard Magnetic Pop-Up, des barres de fixation pour les panneaux avec du ruban 3M, un jeu de barres de construction, une bande magnétique 3M et un jeu de panneaux avant et latéraux.

3x3 (in trolley case)	5907451660959	22 kg
3x3 (in case counter)	5907451665961	22 kg
3x4 (in trolley case)	5907451660966	26 kg
3x4 (in case counter)	5907451665978	26 kg

Case counter and trolley bag - page 66

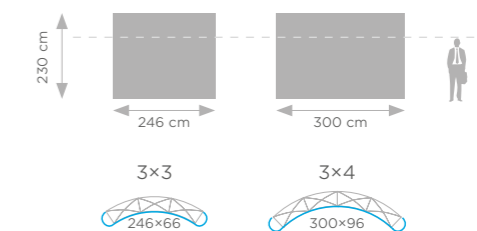

Recommended media and printing technology for this system:



# PREMIUM MAGNETIC POP-UP STRAIGHT

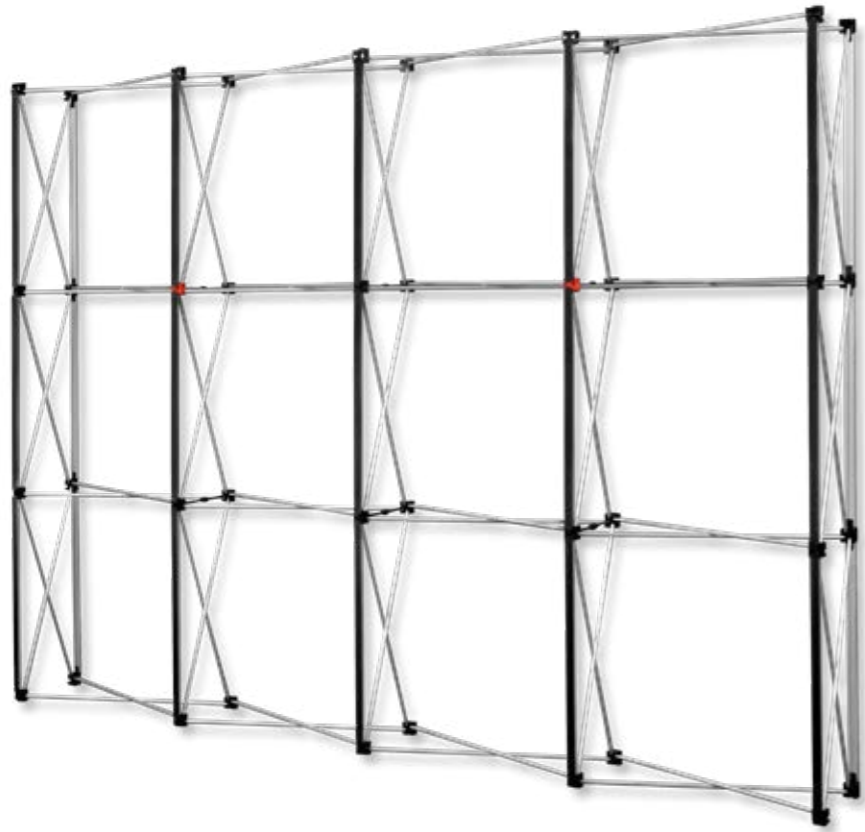

- high quality of construction
- "pop up" mechanism - express unfolding
- magnetic installation system
- interchangeable briches
- case counter

The set includes: Premium Magnetic Pop-up frame, top bars with adhesive tape for mounting PVC panels, a set of construction bars, a set of PVC panels, case counter.

- hohe Verarbeitungsqualität
- „Pop-Up“-Mechanismus - sofortiges Falten der Wand
- magnetisches Verbindungssystem
- austauschbaren Lamellen
- Koffertheke

Dieses Set enthält: Premium Magnetic Pop-up Wand, Befestigungsstreifen für die Lamellen mit Klebeband, einen Satz Konstruktionsstreifen, einen Satz Lamellen, eine Koffertheke.

- très bonne qualité du produit
- système „pop up“ - montage rapid
- assemblage magnétique des barres de construction et des panneaux
- panneaux interchangeables
- caisse comptoir à roulettes

Le kit comprend: un cadre Premium Magnetic Pop Up, des barres de fixation pour les panneaux, un jeu de barres de construction, un jeu de panneaux, une caisse comptoir à roulettes.

3x3	5907451666364	27 kg
3x4	5907451666371	31 kg

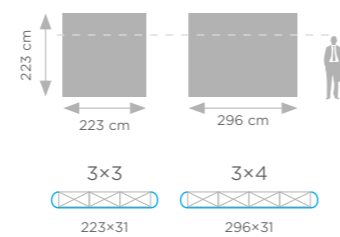

Recommended media and printing technology for this system:



# PREMIUM MAGNETIC POP-UP ARC

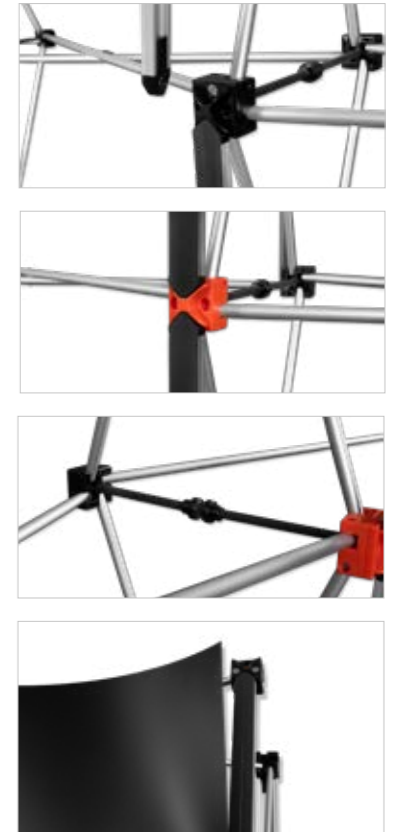
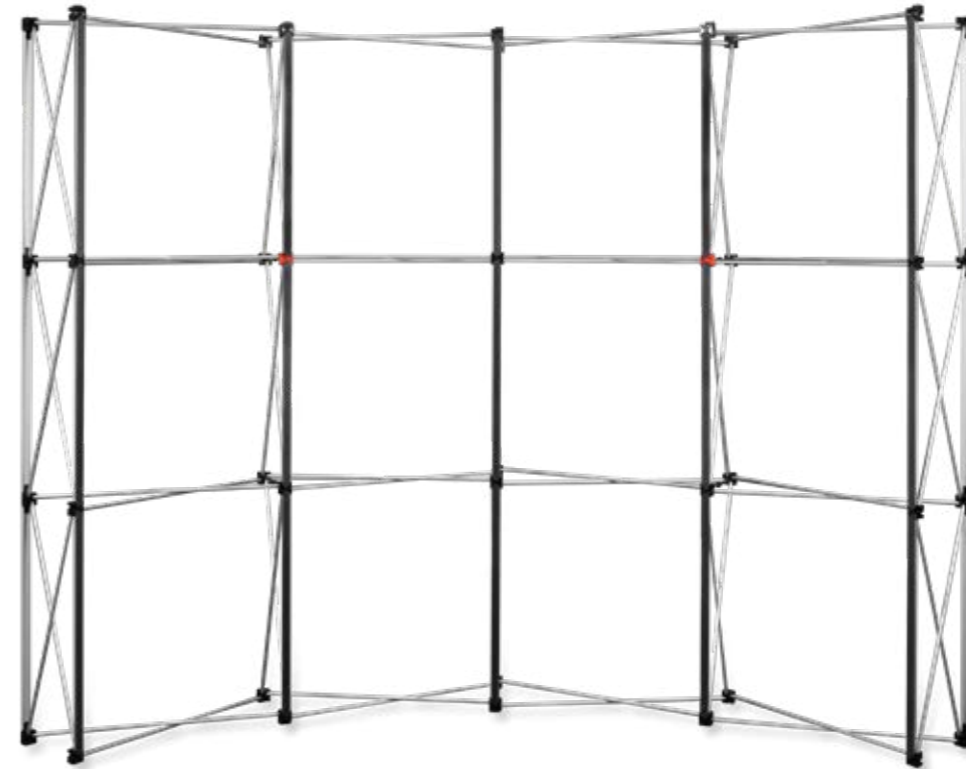

- high quality of construction
- "pop up" mechanism - express unfolding
- magnetic installation system
- interchangeable briches
- case counter

The set includes: Premium Magnetic Pop-up frame, top bars with adhesive tape for mounting PVC panels, a set of construction bars, a set of PVC panels, case counter.

- hohe Verarbeitungsqualität
- „Pop-Up“-Mechanismus - sofortiges Falten der Wand
- magnetisches Verbindungssystem
- austauschbaren Lamellen
- Koffertheke

Dieses Set enthält: Premium Magnetic Pop-up Wand, Befestigungsstreifen für die Lamellen mit Klebeband, einen Satz Konstruktionsstreifen, einen Satz Lamellen, eine Koffertheke.

- très bonne qualité du produit
- système „pop up“ - montage rapid
- assemblage magnétique des barres de construction et des panneaux
- panneaux interchangeables
- une caisse comptoir à roulettes

Le kit comprend: un cadre Premium Magnetic Pop Up, des barres de fixation pour les panneaux, un jeu de barres de construction, un jeu de panneaux, une caisse comptoir à roulettes.

3x3	5907451666388	27 kg
3x4	5907451666395	31 kg

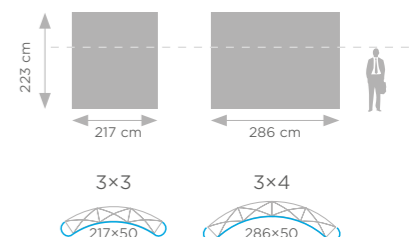

Recommended media and printing technology for this system:



# BLACK PRO MAGNETIC POP-UP STRAIGHT

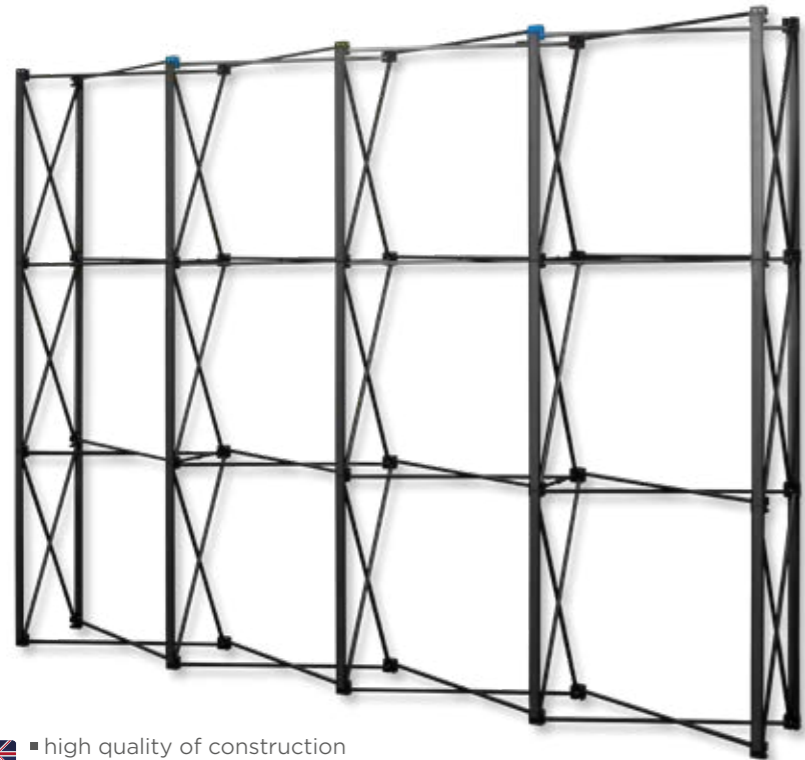

- high quality of construction
- "pop up" mechanism - express unfolding
- magnetic installation system
- interchangeable bristles
- case counter

The set includes: Black Pro Magnetic Pop-up frame, top bars with 3M adhesive tape for mounting PVC panels, a set of construction bars, a set of PVC panels, case counter.

- hohe Verarbeitungsqualität
- „Pop-Up“-Mechanismus - sofortiges Falten der Wand
- magnetisches Verbindungssystem
- austauschbaren Lamellen
- Koffertheke

Dieses Set enthält: Black Pro Magnetic Pop-up Wand, Befestigungsstreifen für die Lamellen mit Klebeband, einen Satz Konstruktionsstreifen, einen Satz Lamellen, eine Koffertheke.

- la structure en aluminium épais garantit une très grande stabilité et la qualité supérieure du produit
- système „pop up“ - montage rapid
- assemblage magnétique des barres de construction et des panneaux
- panneaux interchangeables
- une caisse comptoir à roulettes

Le kit comprend: un cadre Black Pro Magnetic Pop Up, des barres de fixation pour les panneaux, un jeu de barres de construction, un jeu de panneaux et une caisse comptoir à roulettes.

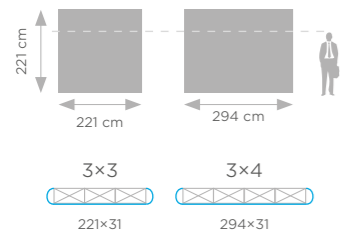

3x3	5907451666319	31 kg
3x4	5907451666326	34 kg

Recommended media and printing technology for this system:



Foil Solvent, UV, Latex

OPTIONAL

# BLACK PRO MAGNETIC POP-UP ARC

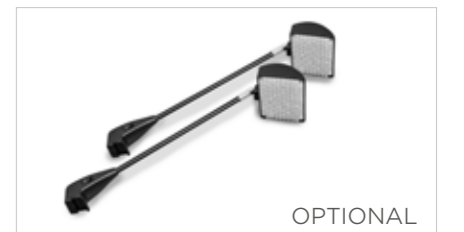
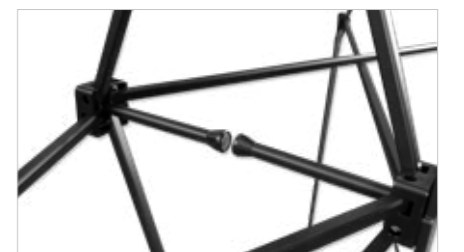
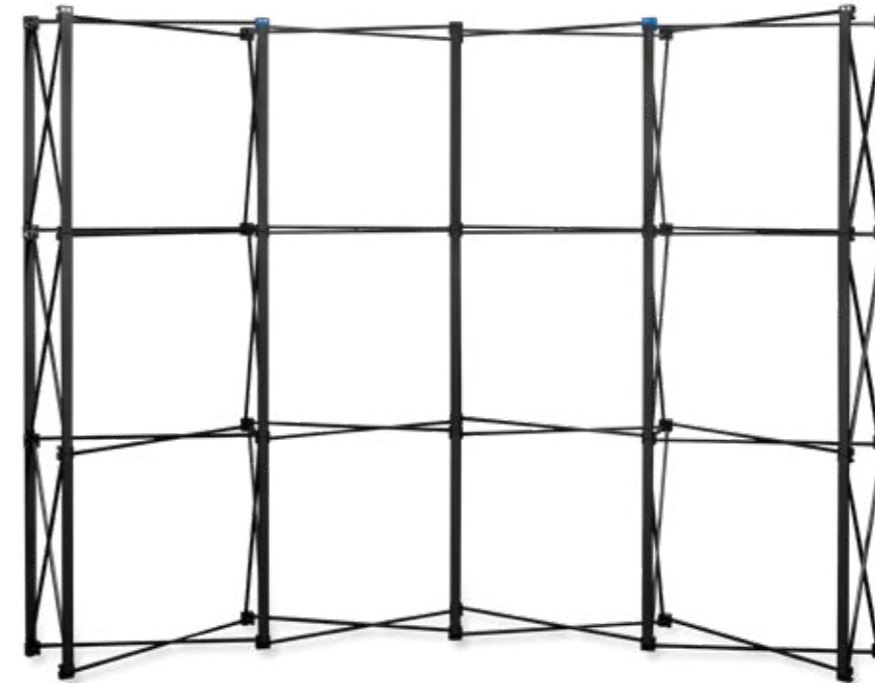

- high quality of construction
- "pop up" mechanism - express unfolding
- magnetic installation system
- interchangeable bristles
- case counter

The set includes: Black Pro Magnetic Pop-up frame, top bars with 3M adhesive tape for mounting PVC panels, a set of construction bars, a set of PVC panels, case counter.

- hohe Verarbeitungsqualität
- „Pop-Up“-Mechanismus - sofortiges Falten der Wand
- magnetisches Verbindungssystem
- austauschbaren Lamellen
- Koffertheke

Dieses Set enthält: Black Pro Magnetic Pop-up Wand, Befestigungsstreifen für die Lamellen mit Klebeband, einen Satz Konstruktionsstreifen, einen Satz Lamellen, eine Koffertheke.

- la structure en aluminium épais garantit une très grande stabilité et la qualité supérieure du produit
- système „pop up“ - montage rapid
- assemblage magnétique des barres de construction et des panneaux
- panneaux interchangeables
- une caisse comptoir à roulettes

Le kit comprend: un cadre Black Pro Magnetic Pop Up, des barres de fixation pour les panneaux, un jeu de barres de construction, un jeu de panneaux et une caisse comptoir à roulettes.

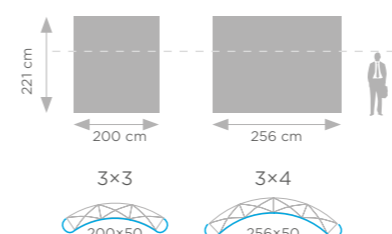

3x3	5907451666333	31 kg
3x4	5907451666340	34 kg

Recommended media and printing technology for this system:



Foil Solvent, UV, Latex

OPTIONAL

# VELCRO POP-UP STRAIGHT



- wall designed for mounting textile graphics on it, using Velcro tape
- one piece graphics without PVC boards
- "pop up" mechanism - express unfolding

This set includes: Velcro Pop-up frame, Velcro tape, Canvas bag.

- die Wand ist für die Montage von Textilgrafiken ohne den Einsatz von Paneelen konzipiert
- „Pop-Up“-Mechanismus - sofortiges Falten der Wand
- Ausdruck in einem Stück, ohne Paneelen

Dieses Set enthält: Velcro Pop-up Wand, Klettband, CanvasTasche.

- système „pop up“ - montage rapid
- impression fixée par velcro
- image = un élément de tissu

Le kit comprend: un cadre Velcro Pop-up, une bande Velcro à coudre dans l'image et un sac type Canvas.

3x3	5907451660973	8,5 kg
3x4	5907451660980	10 kg

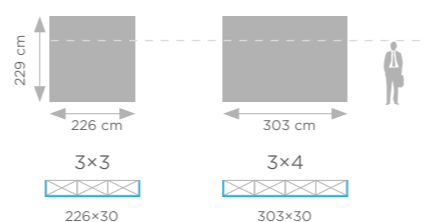

Recommended media and printing technology for this system:



# VELCRO POP-UP ARC



- wall designed for mounting textile graphics on it, using Velcro tape
- one piece graphics without PVC boards
- "pop up" mechanism - express unfolding

This set includes: Velcro Pop-up frame, Velcro tape, Canvas bag.

- die Wand ist für die Montage von Textilgrafiken ohne den Einsatz von Paneelen konzipiert
- „Pop-Up“-Mechanismus - sofortiges Falten der Wand
- Ausdruck in einem Stück, ohne Paneelen

Dieses Set enthält: Velcro Pop-up Wand, Klettband, CanvasTasche.

- système „pop up“ - montage rapid
- impression fixée par velcro
- image = un élément de tissu

Le kit comprend: un cadre Velcro Pop-up, une bande Velcro à coudre dans l'image et un sac type Canvas.

3x3	5907451660997	8,5 kg
3x4	5907451661000	10 kg

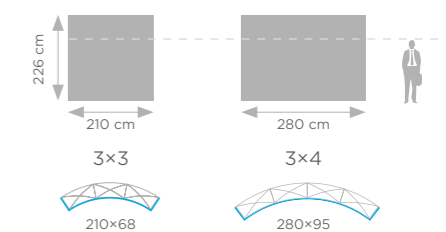

Recommended media and printing technology for this system:



# ATLANTIS STRAIGHT

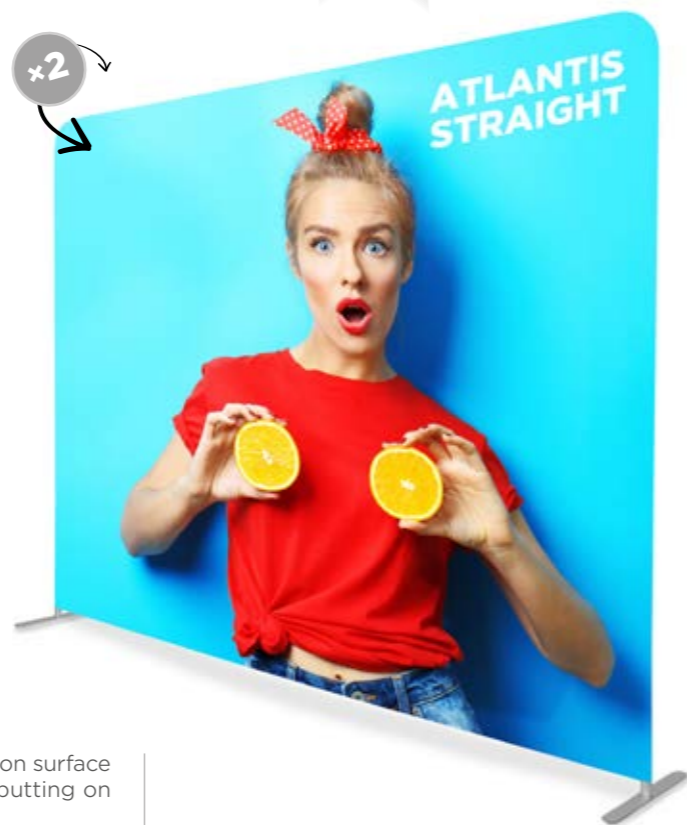
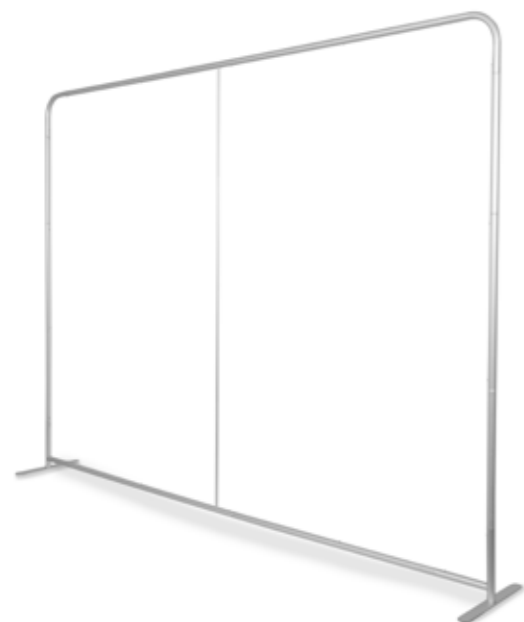

+2

- lightweight, small construction, large graphic presentation surface
- double sided graphic pulled on frame on principle of putting on a sock
- quick assembly
- value for money

This set includes: Atlantis frame and a Canvas bag.

- kleine und leichte Konstruktion, große Grafikfläche
- doppelseitige Grafiken nach dem Prinzip „Dehnen der Socke“
- schnelle Installation
- Preis-Leistungsverhältnis

Dieses Set enthält: Wand Atlantis, Canvas Tasche.

- l'image (imprimée sur tissu) est enfilée comme on enfle une chaussette
- construction ultralégère
- montage extrêmement facile
- prix attractif

Le kit comprend: un mur d'exposition Atlantis, un sac de transport type Canvas.

Size	Barcode	Weight
250x230	5907451661109	7 kg
300x230	5907451661116	8 kg
400x230	5907451661123	9 kg
590x230	5907451663769	15 kg

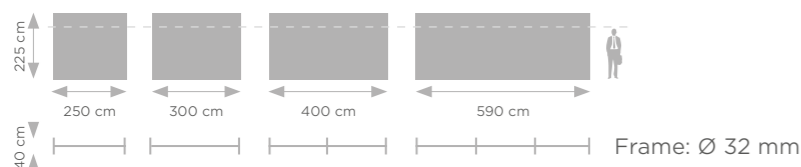

Recommended media and printing technology for this system:



OPTIONAL

# ATLANTIS ARC



+2

- thanks to the curved sides, part of the graphics is also visible from the side.
- lightweight, small construction, large graphic presentation surface
- double sided graphic pulled on frame on principle of putting on a sock
- quick assembly
- value for money

This set includes: Atlantis frame and a Canvas bag.

- mit gekrümmten Seiten ist ein Teil der Grafik seitlich sichtbar
- kleine und leichte Konstruktion, große Grafikfläche
- doppelseitige Grafiken nach dem Prinzip „Dehnen der Socke“
- schnelle Installation
- Preis-Leistungsverhältnis

Dieses Set enthält: Wand Atlantis, Canvas Tasche.

- l'image (imprimée sur tissu) est enfilée comme on enfle une chaussette
- construction ultralégère
- montage extrêmement facile
- prix attractif

Le kit comprend: un mur d'exposition Atlantis, un sac de transport type Canvas.

Size	Barcode	Weight
250x230	5907451661154	5 kg
300x230	5907451661161	6 kg
400x230	5907451661178	7 kg
530x230	5907451661185	10 kg

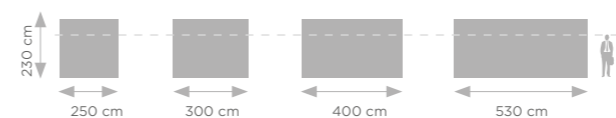

Recommended media and printing technology for this system:

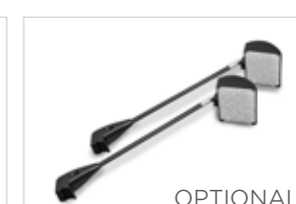
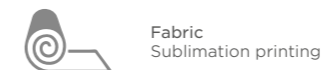

OPTIONAL

# ATLANTIS S-SHAPE



- very impressive version of the Atlantis wall
- lightweight, small construction, large graphic presentation surface
- double sided graphic pulled on frame on principle of putting on a sock
- quick assembly
- value for money

This set includes: Atlantis frame, Canvas bag.

- die glamouröseste Version unter den Wänden von Atlantis
- kleine und leichte Konstruktion, große Grafikfläche
- doppelseitige Grafiken nach dem Prinzip „Dehnen der Socke“
- schnelle Installation
- Preis-Leistungsverhältnis

Dieses Set enthält: Wand Atlantis, Canvas Tasche.

- l'image (imprimée sur tissu) est enfilée comme on enfile une chaussette
- construction ultralégère
- montage extrêmement facile
- prix attractif

Le kit comprend: un mur d'exposition Atlantis, un sac de transport type Canvas.

250x230	5907451663097	5 kg
300x230	5907451661192	6 kg
400x230	5907451661208	7 kg
500x230	5907451661215	9 kg
650x230	5907451661222	11 kg

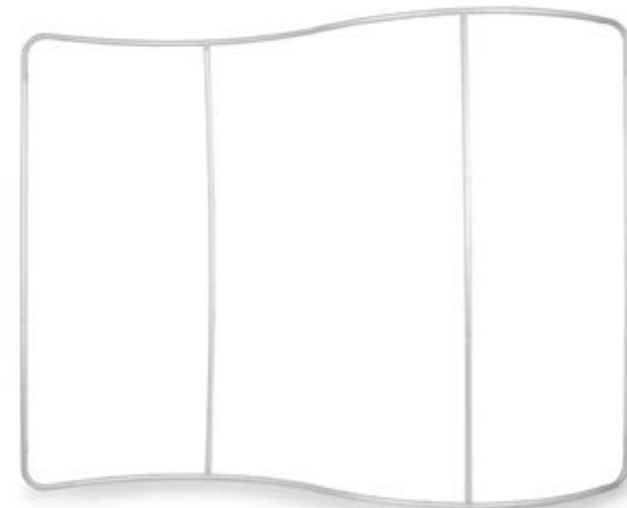
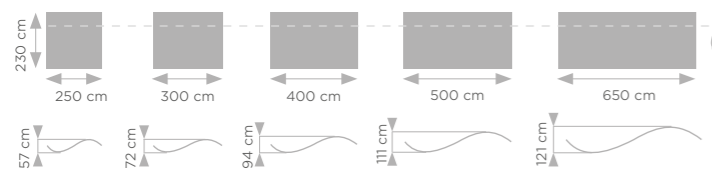

Frame: Ø 32 mm

Recommended media and printing technology for this system:

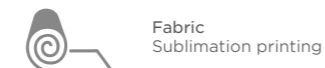

OPTIONAL

# ATLANTIS U-SHAPE

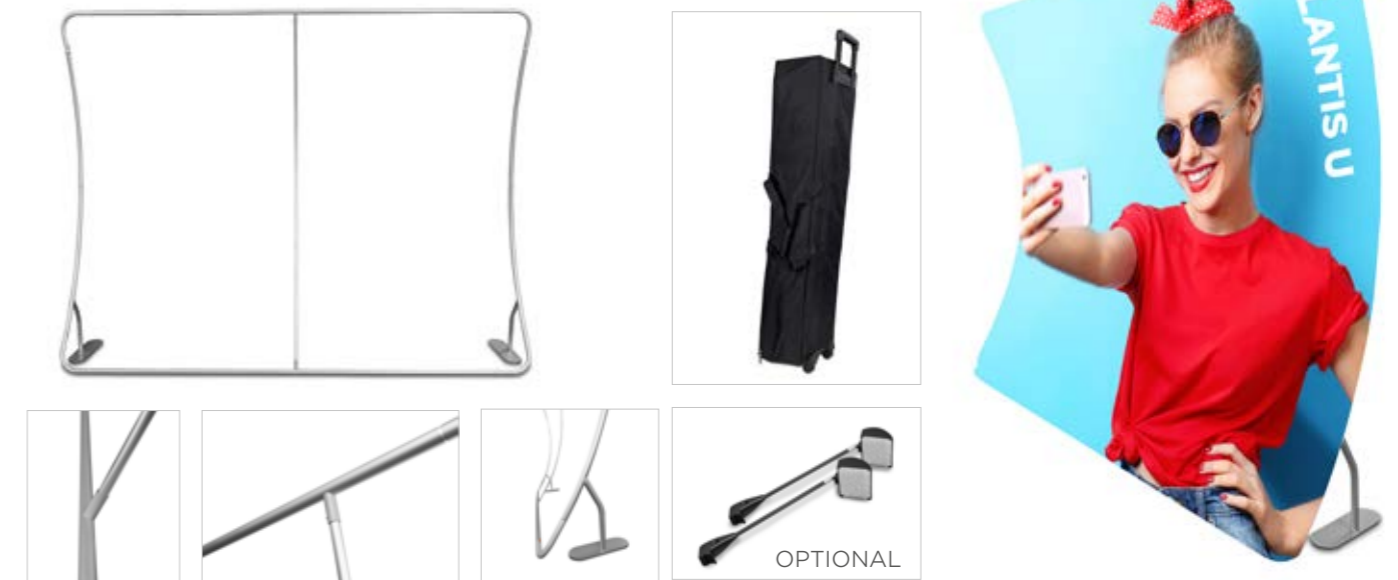

- graphic pulled on frame on principle of putting on a sock
- extra legs make the system very stable

This set includes: Atlantis frame and a Canvas bag.

- doppelseitige Grafiken nach dem Prinzip „Dehnen der Socke“
- stabilisierende Füße enthalten

Dieses Set enthält: Wand Atlantis, Canvas Tasche.

- l'image (imprimée sur tissu) est enfilée comme on enfile une chaussette
- des jambes supplémentaires rend le système très stable

Le kit comprend: un mur d'exposition Atlantis, un sac de transport type Canvas.

250x230	5907451669884	5 kg	230 cm
300x230	5907451661239	6 kg	250 cm, 300 cm, 50 cm

Frame: Ø 32 mm

Recommended media and printing technology for this system:

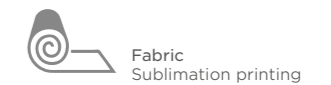

# CONFERENCE ROOM



- ideal for separating a private space for meetings
- double sided graphic pulled on frame on principle of putting on a sock

- ideal zum Abtrennen eines privaten Raums für Besprechungen
- doppelseitige Grafiken nach dem Prinzip „Dehnen der Socke“

- déal pour séparer un espace privé pour des réunions
- l'image (imprimée sur tissu) est enfilée comme on enfile une chaussette

305x150	5907451669860	6,5 kg

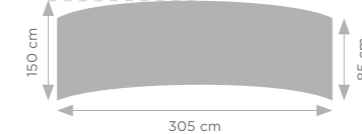
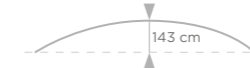

Frame: Ø 32 mm

Recommended media and printing technology for this system:

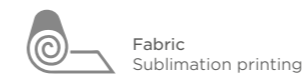



# COMBI SYSTEMS

**UK** Shelving system for Atlantis (straight) walls. Thanks to this simple solution, each wall can become a complete, independent and very functional exhibition system. Perfect for promotional, educational and fair stands. The system has 3 horizontal black shelves made of thick plastic imitating wood, or 3 pockets for catalogs and leaflets, made of thick plexiglass. In the upper part of the system, there is a board on which a company logo or other graphics can be printed (foil).

**DE** Regalsystem für Atlantis (gerade) Wände. Dank dieser einfachen Lösung kann jede Wand zu einem kompletten, unabhängigen und sehr funktionalen Ausstellungssystem werden. Perfekt für Werbe-, Bildungs- und Messestände. Das System verfügt über 3 horizontale schwarze Regale aus dickem Kunststoff, der Holz nachahmt, oder über 3 Taschen für Kataloge und Prospekte aus dickem Plexiglas. Im oberen Teil des Systems befindet sich eine Tafel, auf der ein Firmenlogo oder andere Grafiken (Folie) gedruckt werden können.

**FR** Système d'étagères conçu pour les murs mur d'image Atlantis (droits). Grâce à cette solution simple, chaque mur peut devenir un système d'exposition complet, indépendant et hautement fonctionnel. Il est idéal pour les stands promotionnels, éducatifs et de foire. Le système comprend horizontales noires en plastique épais qui ressemblent à du bois ou de 3 pochettes pour catalogues et brochures en acrylique épais. La partie supérieure du système est équipée d'un panneau sur lequel le logo de l'entreprise ou d'autres graphiques peuvent être imprimés (sur film).

## COMBI 1



## COMBI 2



The set contains the COMBI system only. The Atlantis wall must be purchased separately.

Combi 1	5907451665039	12 kg
Combi 2	5907451665022	8 kg

# VERSUM

**UK** walls intended for big size frontlit banner graphics  
 value for money  
 adjustable frame, which can obtain various sizes  
 stable construction

These sets include: Versum frame and a transport bag.

**DE** wände für Banner-Grafiken mit großen Oberflächen  
 Preis-Leistungsverhältnis  
 verstellbarer Rahmen, der verschiedene Größen erhalten kann  
 stabile Konstruktion

Diese Sets enthalten: Versum Wandrahmen, Transporttasche.

**FR** destinés aux images de bannières de grande surface  
 la structure fonctionne avec des tubes télescopiques  
 grâce auxquels le cadre est réglable et peut avoir différentes dimensions  
 bas prix du système

Le kit comprend: un cadre Versum, un sac de transport.

Recommended media and printing technology for this system:



## VERSUM

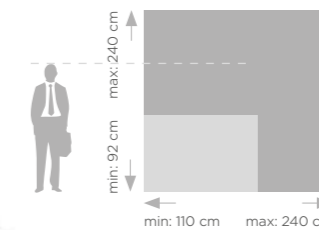

5907451661086	5,8 kg

Frame: Ø 22 mm

## VERSUM XL

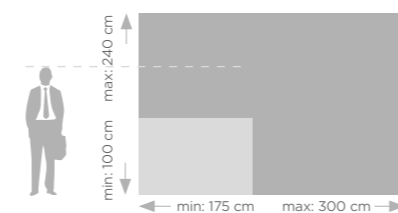

5907451661093	9,5 kg

Frame: Ø 32 mm



## ADVERTISING WALL ACCESSORIES

### BAGS AND CASES

#### I CASE COUNTER



- 2 in 1 - trolley case and a counter
- excellent set together with the wall
- varnished tabletop is an additional option

This set includes: Counter, PVC Panel board and a tape for graphics assembly.

- 2 in 1 - Koffer und Theke
- perfekte Präsentation Duo komplett mit Wand
- Lackierte Arbeitsplatte ist eine Option

Dieses Set enthält: Theke, PVC und Klebeband für Grafikmontage.

- 2en1: sac à roulettes et comptoir
- excellent ensemble avec le mur
- le plateau de table verni est une option supplémentaire

Le kit comprend: une caisse comptoir à roulettes, une bande magnétique 3M et un panneau pour coller l'image imprimée.

#### I CANVAS BAG



Recommended for walls with graphic not presented on PVC boards.

Empfohlen für Wände mit Grafiken, die nicht auf PVC-Platten dargestellt sind.

Recommandé pour les murs dont le graphisme n'est pas présenté sur PVC.

Canvas Bag	5907451662946	1 kg
Trolley case	5907451660867	5 kg
Counter	5907451660874	12 kg
Counter top	5907451663073	6 kg

#### I TROLLEY CASE



- additional padding makes this case very stable
- easy to carry thanks to wheels

- sehr langlebig, mit extra Futter
- einfacher Transport dank Rädern

- un rembourrage supplémentaire rend cette valise très stable
- facile à transporter grâce à ses roulettes

### LIGHTING

#### I HALOGEN



5907451660911

#### I LED



LED for Mega Seg system	5907451668887
LED for Pop-up & Atlantis walls	5907451660928
LED for Premium Pop-up walls	5907451666418



# EXHIBITION BOOTHS

## LUMIX™

PREMIUM LINE

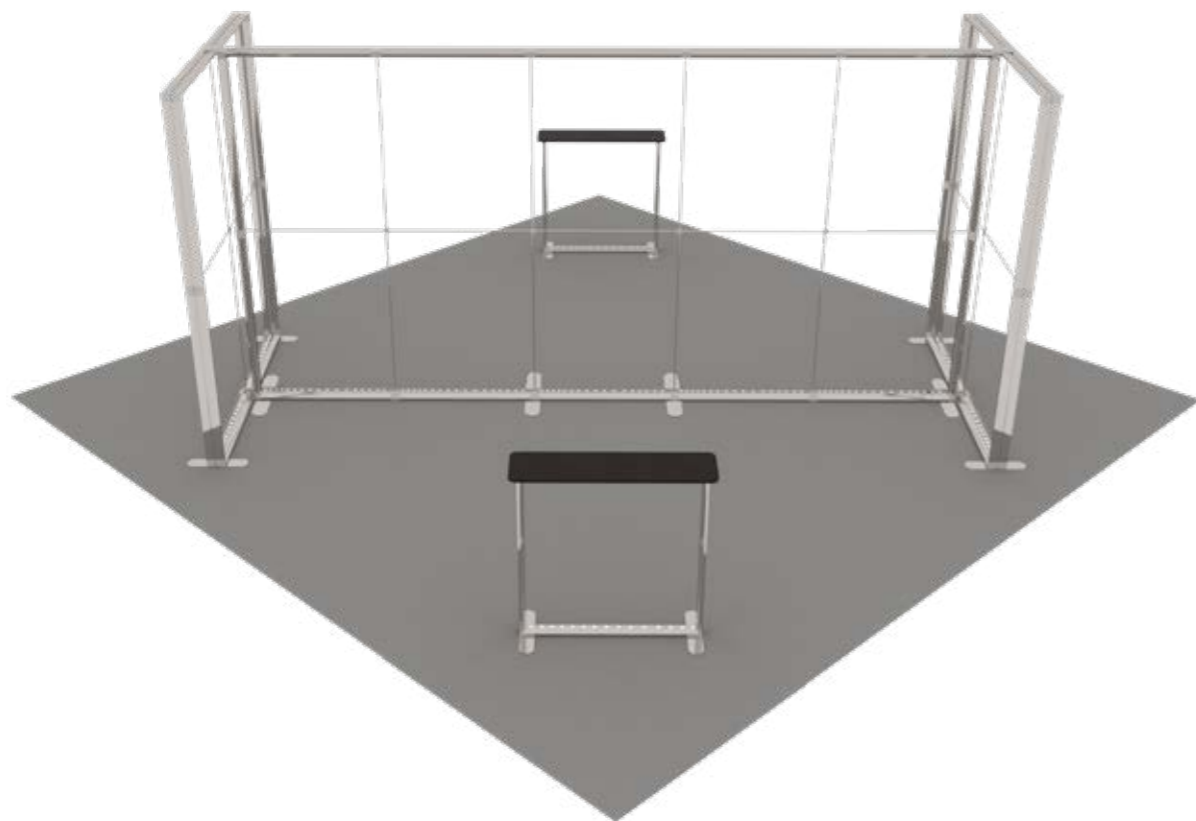

- LED
- 12 cm  
WIDE ALUMINIUM PROFILE
- MODULAR CONSTRUCTION
- DOUBLE SIDED
- NO TOOLS
- SILICONE TAPE MOUNTED PRINTOUT
- WHEELED BAG

**THE LUMIX EXHIBITION BOOTH CONSISTS OF THE LUMIX SYSTEM (MORE INFO PAGES 6-7) AND THE LUMIX COUNTER (MORE INFO - PAGE 14)**

- eye-catching LED exhibition stand
- **wide aluminium profile (12 cm)**
- no tools assembly
- silicon tape mounted printout
- sturdy wheeled transport bag

The set includes: LUMIX system, LUMIX counter, wheeled transport bags, assembly accessories.

- auffällige LED-Messestand
- **breiter Aluminiumrahmen (12 cm)**
- werkzeuglose Montage
- mit Silikonband befestigte Ausdrücke
- robuste Transporttasche auf Rädern

Das Set enthält: LUMIX-System, LUMIX-Theke, Tasche auf Rädern, Montagehilfsmittel.

- éclairage LED intégré
- **cadre épais en aluminium (12 cm)**
- montage sans outils
- l'image montée à l'aide d'une bande silicone
- sac à roulettes

Le kit comprend: système LUMIX, comptoir LUMIX, sac de transport à roulettes, accessoires de montage.

16 m <sup>2</sup> /island	5907451667996
25 m <sup>2</sup> /island	5907451667989
36 m <sup>2</sup> /island	5907451667972
9 m <sup>2</sup> /peninsula	5907451667965
12 m <sup>2</sup> /peninsula	5907451667941
15 m <sup>2</sup> /peninsula	5907451667934
16 m <sup>2</sup> /peninsula	5907451667958
18 m <sup>2</sup> /peninsula	5907451667910
24 m <sup>2</sup> /peninsula/1 counter	5907451667927
24 m <sup>2</sup> /peninsula/2 counters	5907451667903
9 m <sup>2</sup> /corner	5907451667897
15 m <sup>2</sup> /corner	5907451667859
25 m <sup>2</sup> /corner	5907451667873

### EXAMPLES OF THE LUMIX EXHIBITION BOOTHS



Recommended media and printing technology for this system:



Fabric Sublimation printing

## LUMIX™ EXHIBITION BOOTHS ACCESSORIES

### MONITOR HOLDER

🇬🇧 A special monitor holder allows additional multimedia presentation. This is an ideal alternative to traditional posters or banners, which increases the efficiency of the entire booth.

🇩🇪 Eine spezielle Monitorhalterung ermöglicht eine zusätzliche multimediale Präsentation. Dies ist die ideale Alternative zu herkömmlichen Plakaten oder Bannern, was die Effizienz des gesamten Standes erhöht.

🇫🇷 Le porte-écran spécial permet une présentation multimédia supplémentaire de l'offre. Il est une alternative idéale aux affiches ou aux bannières traditionnelles, augmentant ainsi l'attrait du stand.

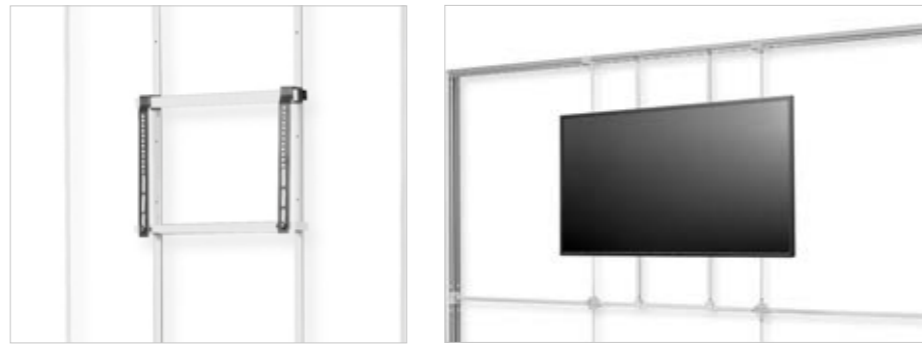

### LOCKER SET

🇬🇧 The illuminated storage room with a code lock is a great solution to store materials needed during trade fairs or other promotional events.

🇩🇪 Das beleuchtete Kabine mit Codeschloss ist eine hervorragende Lösung für die Aufbewahrung von Materialien, die für Messen oder andere Werbeveranstaltungen benötigt werden.

🇫🇷 Le casier lumineux avec serrure à code est une solution idéale pour stocker le matériel nécessaire lors de salons professionnels ou d'autres événements.



### SHELVES SYSTEM

🇬🇧 The shelves system makes the LUMIX products even more functional. The shelves can be mounted horizontally or diagonally.

🇩🇪 Mit dem LUMIX Regalsystem ist LUMIX noch funktionaler für Messen oder Promotionen. Die Regale können waagrecht oder diagonal montiert werden.

🇫🇷 Grâce aux étagères le système LUMIX devient un espace encore plus fonctionnel pour les salons. Les étagères peuvent être installées horizontalement ou en diagonale.



COUNTERS & BROCHURE HOLDERS



## PROMO COUNTERS

- thanks to the simplicity of assembly, they have gained great popularity in many markets
- the walls of this system are made of cellular PVC, mounted to the wooden tabletop and wooden base with velcro straps
- ultralight counter

These sets include: counter top and base packed in transport bag, PVC panel packed in separate transport tube.

- diese Promotheken sind aufgrund ihrer außergewöhnlich einfachen Installation in vielen Märkten sehr beliebt geworden.
- die Theke besteht aus einer Tischplatte (aus Holz) und einer Basis (aus Holz), die ein PVC Paneel verbindet
- sehr leichte Konstruktion

Diese Sets enthalten: einen Fuß und eine Tischplatte verpackt in einer Transporttasche, PVC Paneel verpackt in einem separaten Transportrohr.

- apprécié avant tout pour la simplicité de montage
- plateau en bois solide
- les parois en PVC cellulaire sont assemblées au plateau et au socle à l'aide de fermetures velcro

Le kit comprend: un plateau en bois et un socle en bois emballés dans un sac de transport, un panneau PVC emballé dans un tube de transport séparé.

Recommended media and printing technology for this system:



### PROMO 0

NEW STRONG TOP

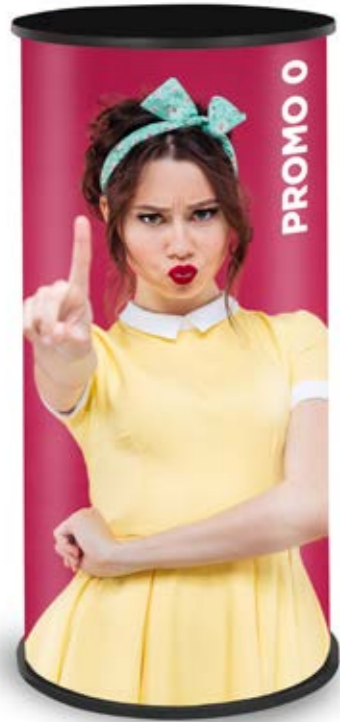

5907451661437



5 kg

Counter

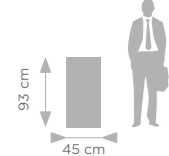

Table top



### PROMO 1

NEW STRONG TOP



Product also available with shelf.



5907451661444



10 kg

Counter



Table top

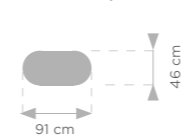

### PROMO 2

BEST SELLER

NEW STRONG TOP



Product also available with shelf.



Counter

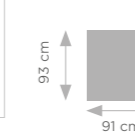

Table top



5907451661451



10 kg

### PROMO 3

NEW STRONG TOP



Counter

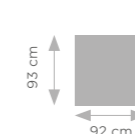
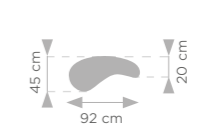

Table top



5907451663714



8 kg

### PROMO 4

NEW STRONG TOP



Product also available with shelf.



Counter



Table top

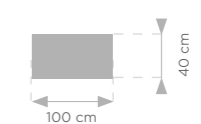

5907451669112



10 kg

## PRESTON COUNTERS

- heavy, very solid and stable construction
- high quality and very impressive graphics mount using a silicone band
- thanks to the use of fabric as a graphic carrier, this counter can be illuminated from inside

These sets include: Preston counter and a transport bag.

- solide und stabile Konstruktion
- hochwertige Verarbeitung
- grafiken mit Silikonband montiert
- dank der Verwendung von Stoff als Träger der Grafik kann der Ladentisch von innen beleuchtet werden

Diese Sets enthalten: Theke Preston und Transporttasche.

- un comptoir très solide et résistant qui peut être rétroéclairé de l'intérieur
- l'installation de l'image à l'aide de bande silicone ne prend que quelques secondes
- le plateau en bois et le socle „pieds” en métal

Le kit comprend: un comptoir Preston, un sac de transport.

Recommended media and printing technology for this system:

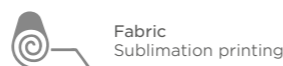

## PRESTON OVAL

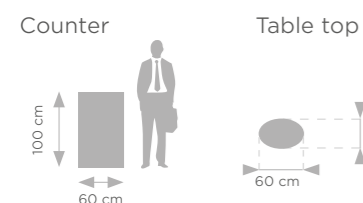

## PRESTON TRIANGLE

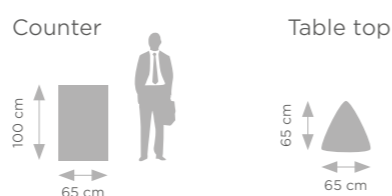

## PRESTON WAIST



Counter

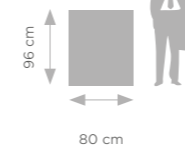
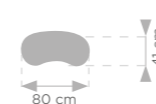

Table top



## PRESTON RECTANGLE



Counter

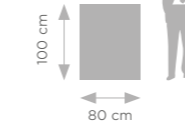
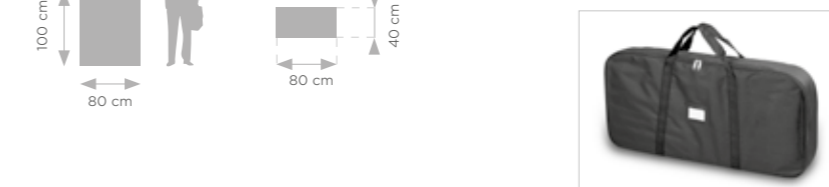
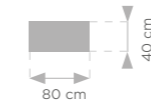

Table top



## PRESTON XXL



Counter

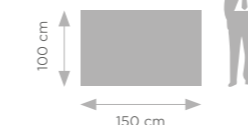
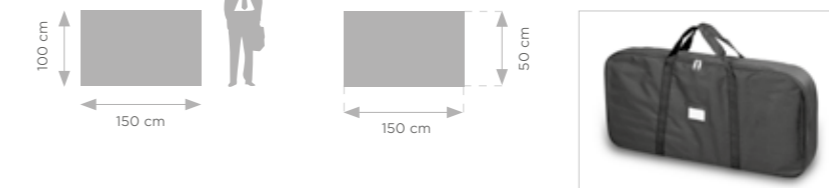
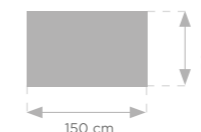

Table top



## POP-UP VELCRO

- great complement to POP-UP Velcro wall
- graphics mounted with Velcro tape
- ultralight, useful, practical shelf in set

These sets include: Pop-up Velcro counter, Canvas bag.

- perfekte Ergänzung zu POP-UP Velcro wand
- Grafik mit Klettverschluss montiert
- kommt mit einem praktischen Regal

Dieses Set enthält: Theke Velcro Pop-up und Canvas Tasche

- mécanisme „pop up“ – dépliage rapide du cadre
- installation rapide de l'impression à l'aide de fermetures velcro
- construction légère et stable
- étagère pratique

Le kit comprend: un comptoir Velcro Pop-up, un plateau en bois, du Velcro pour coudre l'image, une étagère en bois, un sac de transport.

Recommended media and printing technology for this system:



5907451661505 | 12,3 kg

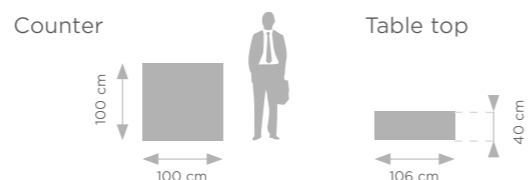

## POP-UP 2x1

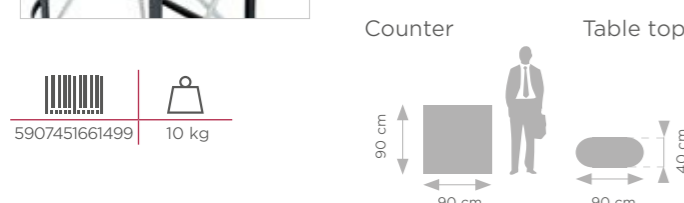

- POP-UP construction
- graphics mounted on PVC boards
- attractive appearance

These sets includes: Pop-up counter, Canvas bag.

Recommended media and printing technology for this systems:



## POP UP 2x2

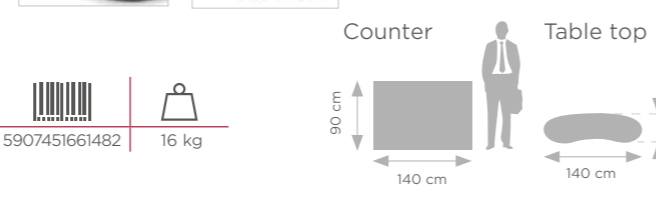

- Grafik auf PVC Paneelen montiert
- leichtes POP-UP Konstruktion
- attraktives Aussehen

Diese Sets enthalten: Theke Pop-up und Canvas Tasche.

- mécanisme „pop up“ – dépliage rapide du cadre
- installation du panneau à l'aide d'aimants
- étagère pratique et plateau laqué

Le kit comprend: un comptoir Pop-Up, un panneau PVC, une bande magnétique, un sac de transport.

## PROMO 2 PLUS

- the walls of this system are made of cellular PVC, mounted to the wooden table-top and wooden base with velcro straps
- practical topper

This set includes: counter top, base and topper packed in transport bag, PVC panel packed in separate transport tube.

- die Theke besteht aus einer Tischplatte (aus Holz) und einer Basis (aus Holz), die ein PVC Paneel verbindet
- praktischer Topper

Das Set enthält: einen Fuß, eine Tischplatte und ein Topper verpackt in einer Transporttasche, PVC Paneel verpackt in einem separaten Transportrohr.

- plateau en bois solide
- assemblage à l'aide de fermetures velcro, sans outils
- topper pratique

Le kit comprend: dans le sac de transport - un plateau en bois, un socle en bois, un topper; dans le tube de transport - un panneau PVC.



5907451661475 | 10,5 kg



Recommended media and printing technology for this system:



Product also available with shelf.



## TOPPER

- counter made entirely of PVC board
- ultralight and stable construction
- perfect as a tool during supermarket promotions

This set includes: Topper counter and a carrying bag.

- komplett aus PVC
- sehr leichte, aber stabile Konstruktion
- ideal für den Einsatz als Werkzeug bei der Förderung in Supermärkten

Dieses Set enthält: Theke Topper und Transporttasche.

- un comptoir léger et stable, entièrement réalisé en panneau PVC
- structure légère et stable
- topper pratique

Le kit comprend: un cadre du comptoir Topper, un sac de transport.

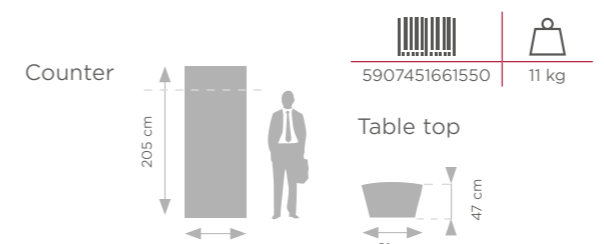

Recommended media and printing technology for this system:

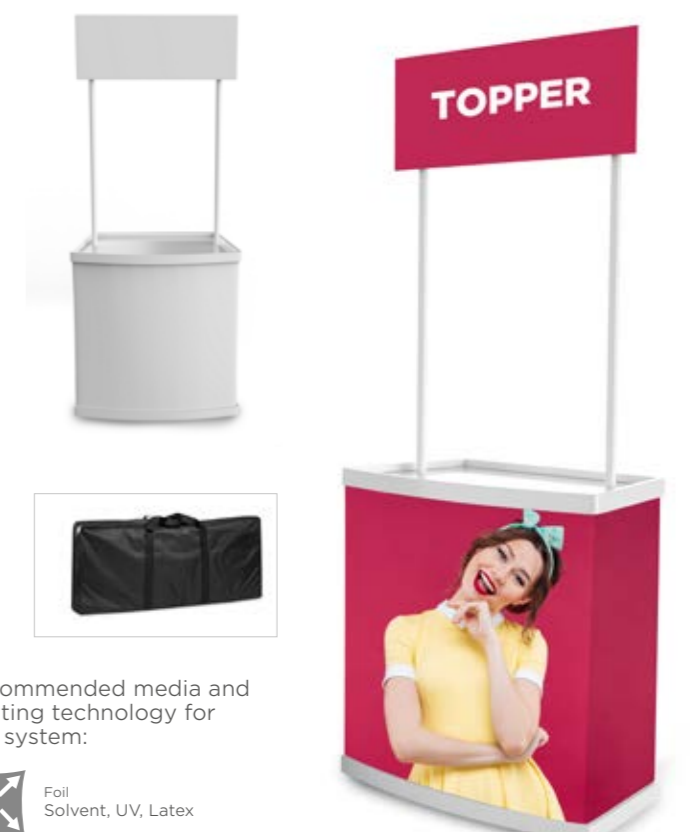

## PRESTON AUTOMATIC COUNTERS

- automatic and very quick assembly
- stable base and sizable top
- perfect choice for fair and promoting purposes

- Automatische und sehr schnelle Montage
- Stabile Basis und ansehnliche Oberseite
- Perfekte Wahl für Messe - und Werbezwecke

- dépliage automatique du comptoir
- construction solide
- un choix idéal pour les foires et les promotions

These sets include: Preston counter and a transport bag.

Diese Sets enthalten: Theke Preston und eine Transporttasche.

Le kit comprend: un comptoir Preston, un sac de transport.

Recommended media and printing technology for this system:



### PRESTON AUTOMATIC OVAL



Counter Table top

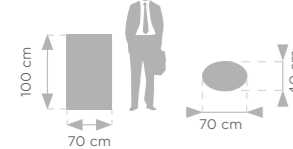

### PRESTON AUTOMATIC RECTANGLE

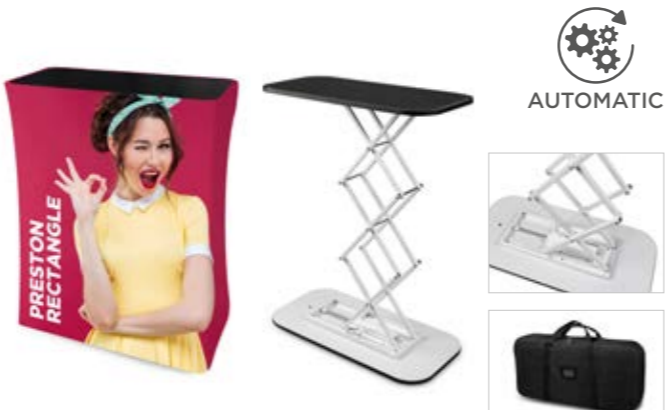

Counter Table top

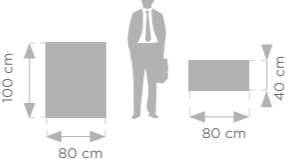

### PRESTON AUTOMATIC OVAL LED



Counter Table top

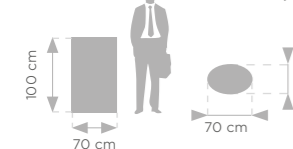

### PRESTON AUTOMATIC RECTANGLE LED



Counter Table top

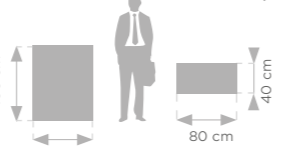

## LUMIX™ COUNTER

NEW!

PREMIUM LINE

- double-sided system
- wide aluminium profile (12 cm)
- integrated LED lighting
- no tools assembly
- silicon tape mounted printout
- wheeled transport bag

- doppelseitige, auffällige Konstruktion
- stabiler Aluminiumrahmen (12 cm)
- integrierte LED-Beleuchtung
- Silikonband befestigte Druck
- werkzeuglose Montage
- Tasche auf Rädern

- système double face
- large profilé en aluminium (12 cm)
- éclairage LED intégré
- assemblage sans outils
- impression sur ruban adhésif silicone
- sac de transport à roulettes

The set includes: LUMIX counter, power adapter, wheeled bag.

Das Set enthält: LUMIX Theke, Netzteil, Tasche auf Rädern.

Le kit comprend: un comptoir LUMIX, une alimentation, un sac de transport à roulettes.



Recommended media and printing technology for this system:



Counter Table top



## LED BOX™ COUNTER

- double-sided LED system
- durable aluminium frame (8 cm)
- no tools assembly
- silicon tape mounted printout

- beidseitiges LED-System
- stabiler Aluminiumrahmen (8 cm)
- Montage ohne Werkzeug
- Silikonband montiert Ausdruck

- rétroéclairé, double face et facile à utiliser
- aluminium anodisé solide (8 cm)
- montage sans outils
- l'image montée à l'aide d'une bande silicone

The set includes: LED BOX counter, power adapter, transport bag.

Die Set enthält: Theke LED BOX, Netzteil, Transporttasche.

Le kit comprend: un comptoir LED BOX, une alimentation, un sac de transport.



Recommended media and printing technology for this system:



Counter Table top

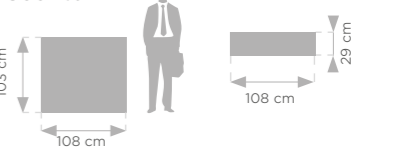



# BROCHURE HOLDERS

## MONTANA SILVER



Product packed in transport bag or aluminium case.

A4	5907451660553	5,2 kg
A3	5907451669365	7,5 kg

- two-sided access to presented materials
  - designed for brochures in A4 and A3 format
  - small dimension after folding
  - made of aluminium and metal
- zwei-Wege-Zugriff auf die eingereichten Katalogen
  - für A4 und A3 Katalog geeignet
  - kleine Größe nach dem Falten
  - stand aus Aluminium und Metall
- accès aux documents présentés des deux côtés
  - conçu pour les brochures au format A4 et A3
  - faible poids, petites dimensions après le démontage
  - construction solide en aluminium

## MONTANA BLACK



- two-sided access to presented materials
  - designed for brochures in A4 and A3 format
  - small dimension after folding
  - made of aluminium and metal
- zwei-Wege-Zugriff auf die eingereichten Katalogen
  - für A4 und A3 Katalog geeignet
  - kleine Größe nach dem Falten
  - stand aus eloxiertem Aluminium und Metall
- accès aux documents présentés des deux côtés
  - conçu pour les brochures au format A4 et A3
  - faible poids, petites dimensions après le démontage
  - construction solide en aluminium

A4	5907451668962	5,2 kg
A3	5907451668955	7,5 kg

## BOSTON



- bestseller
  - made entirely of metal, powder coated black
  - small dimension, lightweight frame
- bestseller
  - Boston ist komplett aus schwarz pulverbeschichtetem Metall gefertigt
  - kleine Größe und leichtes Design
- construction métallique légère
  - prix avantageux
  - les petites dimensions

A4 5907451660546 4,3 kg

## ATLANTA



- solid metal construction
  - two-sided access to presented materials
  - small size after folding
- robuste Konstruktion aus Metall
  - beidseitiger Zugang zu A4-Material
  - geringe Größe nach dem Falten
- construction solide en métal
  - accès des deux côtés aux documents présentés
  - petites dimensions après le démontage

A4 5907451669051 6,6 kg

## COLUMBIA



- pockets made of thick transparent plexiglass board
  - chromed base
  - a grip making it easy to handle
  - handy backpack included
- Taschen aus dickem, transparentem Plexiglas hergestellt
  - verchromte Basis
  - ein Griff für den einfachen Transport
  - bequemer Rucksack enthalten
- porte-brochures d'une élégance exceptionnelle dont les poches ont été réalisées en plexiglas épais et transparent
  - le socle chromé
  - poignée facilitant le transport
  - sac à dos pratique pour le transport

A4 5907451660560 5 kg

## LINCOLN



- extremely durable and strong stand
  - made of metal, powder coated gray and black
  - designed for catalogs and brochures in A4 format
  - bag included
- extrem starke Konstruktion
  - komplett aus pulverbeschichtetem Metall
  - für A4 Kataloge geeignet
  - Tasche enthalten
- construction exceptionnellement durable et solide
  - réalisé entièrement en métal, thermolaqué en gris et noir
  - conçu pour présenter les dépliants/catalogues au format A4
  - comprend un sac de transport

A4 5907451662489 6,5 kg

## COUNTER DALLAS



- 🇬🇧 2in1 - counter and brochure holder
  - catalogs in A4 and A3 format will fit here
  - stable construction
- 🇩🇪 2in1: Theke und Prospekthalter
  - geeignet für A4 und A3 Kataloge
  - stabile Konstruktion
- 🇫🇷 2en1 - comptoir et présentoir pour dépliants
  - petites dimensions après le démontage
  - Il sert à présenter les catalogues au format A4 et A3



5907451663592



10 kg

## COUNTER CONCORD



- 🇬🇧 2in1 - counter and brochure holder
  - catalogs in A4 format will fit here
  - elegant table top made of light wood
  - counter folds into small dimensions and fits in a durable, elegant aluminum case
- 🇩🇪 2in1: Theke und Prospekthalter
  - geeignet für A4 Kataloge
  - elegante Tischplatte aus Holz
  - die Theke lässt sich in kleinen Abmessungen zusammenfalten und passt in ein elegantes Aluminiumgehäuse
- 🇫🇷 2en1 - comptoir + présentoir pour dépliants
  - le présentoir est conçu pour les dépliants/catalogues A4
  - plateau élégant en bois
  - petites dimensions après le démontage
  - valise en aluminium



A4 5907451660577



8 kg

## VIRGINIA

- 🇬🇧 2in1 - info stand and brochure holder in one
  - A4 or universal pocket
  - snap frame for customized poster
  - very stable and strong system
- 🇩🇪 2in1 - Infostand und Broschürenhalter in einem
  - A4 oder Universaltasche
  - Schnapprahmen für individuelles Poster
  - sehr stabiles und starkes System
- 🇫🇷 2en1 - stand d'information et porte-brochures
  - construction très solide en métal massif, thermolaqué en noir mat
  - plaque d'information intégrée
  - la poche pour dépliants est réalisée en acrylique très épais et conçue pour les formats maximum A4

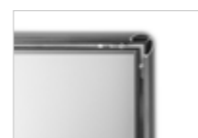

5907451664889



9 kg



POSTER FRAMES AND RAILS

# POSTER RAILS

POSTERLEISTEN

PROFILÉS PORTE-AFFICHES



- wide choice of sizes - custom sizes available on request
- possibility of mounting to a wall or ceiling
- "Express Clip" system - quick and simple assembly and graphics exchange
- thick profile made of anodized aluminum

This set includes: top rail with hooks and bottom rail.

- große Auswahl an Breiten
- möglichkeit der Montage an der Wand oder Decke
- „Express Clip“ System - sofortige und einfache Montage und Austausch von Grafiken
- elegantes Aussehen
- dickes Profil aus eloxiertem Aluminium

Dieses Set enthält: obere Schiene mit Haken und untere Schiene.

- grand choix de largeurs - les moules peuvent être fabriquées sur mesure pour le client
- possibilité de fixation au mur ou au plafond
- système „Express Clip“ pour un montage et un remplacement
- rapides et faciles des graphiques
- aspect élégant
- profilé épais en aluminium anodisé

Le kit comprend: un profil supérieur avec crochets et un profil inférieur.

Recommended media and printing technology for this system:



## STANDARD

40 cm	5907451662038	0,20 kg
60 cm	5907451661635	0,30 kg
85 cm	5907451660249	0,40 kg
100 cm	5907451660256	0,45 kg
120 cm	5907451660263	0,55 kg
150 cm	5907451660270	0,70 kg
200 cm	5907451660287	0,90 kg

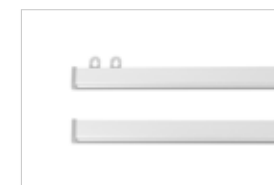

## SLIM

40 cm	5907451662045	0,20 kg
60 cm	5907451662052	0,30 kg
85 cm	5907451662069	0,40 kg
100 cm	5907451662076	0,45 kg
120 cm	5907451662083	0,55 kg
150 cm	5907451662090	0,70 kg
200 cm	5907451663707	0,90 kg

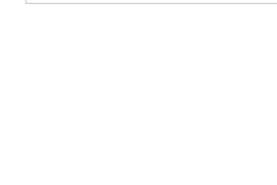

## CLIP

40 cm	5907451662526	0,20 kg
60 cm	5907451662533	0,30 kg
85 cm	5907451662540	0,40 kg
100 cm	5907451662496	0,45 kg
120 cm	5907451662502	0,55 kg
150 cm	5907451662519	0,70 kg

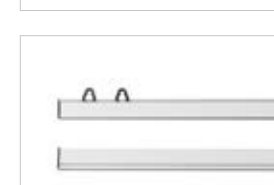
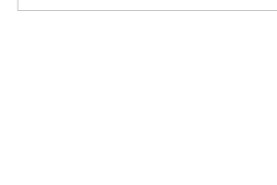
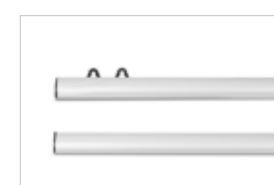

## TWIN

40 cm	5907451662236	0,20 kg
60 cm	5907451662243	0,30 kg
85 cm	5907451662250	0,40 kg
100 cm	5907451662267	0,45 kg
120 cm	5907451662274	0,55 kg
150 cm	5907451662281	0,70 kg



# VERTICO HANGING FRAMES



- aluminium profile: 25 mm**
  - poster cover with UV-filter protects the printout from fading graphic colours
  - "clip-clap" system - quick and simple assembly and graphics exchange
  - vertical or horizontal assembly
- Profilbreite (aluminium): 25 mm**
  - Plakathülle mit UV-Filter schützt den Ausdruck vor dem Verblässen der Grafikfarben
  - "Clip-Clap" System - sofortige und einfache Montage und Austausch von Grafiken
  - vertikale oder horizontale Montage
- profil large (aluminium): 25 mm**
  - changement rapide de l'image grâce aux bords du cadre („clip-clap“)
  - couche avec filtre UV protégeant l'impression de la perte de couleurs
  - montage vertical ou horizontal
- doublesided aluminium frame: 32 mm**
  - mounted on the ceiling
  - simple and elegant design
  - "clip-clap" system - quick and simple graphics assembly and exchange
- doppelseitiger Aluminiumrahmen: 32 mm**
  - an der Decke montiert
  - einfaches und elegantes Design
  - „Clip-Clap“-System - schnelle und einfache Montage und Austausch der Grafiken
- cadre en aluminium double face: 32 mm**
  - changement rapide de l'image grâce aux bords du cadre („clip clap“)
  - présentation de l'image des deux côtés
  - câble en acier assurant une suspension sûre du cadre

Recommended media and printing technology for this system: Paper Solvent, UV, Latex

A2	5907451665688	2,1 kg
A1	5907451665671	3,4 kg
B2	5907451665701	2,7 kg
B1	5907451665695	4,3 kg



# SNAP FRAMES STANDARD

- aluminium profile: 25 mm**
  - poster cover with UV-filter protects the printout from fading graphic colours
  - "clip-clap" system - quick and simple assembly and graphics exchange
  - vertical or horizontal assembly
- Profilbreite (aluminium): 25 mm**
  - Plakathülle mit UV-Filter schützt den Ausdruck vor dem Verblässen der Grafikfarben
  - "Clip-Clap" System - sofortige und einfache Montage und Austausch von Grafiken
  - vertikale oder horizontale Montage
- profil large (aluminium): 25 mm**
  - changement rapide de l'image grâce aux bords du cadre („clip-clap“)
  - couche avec filtre UV protégeant l'impression de la perte de couleurs
  - montage vertical ou horizontal

Recommended media and printing technology for this system: Paper Solvent, UV, Latex

## SNAP FRAMES SILVER



A5	5907451662557	0,30 kg
A4	5907451661567	0,45 kg
A3	5907451661574	0,65 kg
A2	5907451661581	1,15 kg
A1	5907451661598	1,90 kg
A0	5907451661604	3,60 kg
B3	5907451662564	0,95 kg
B2	5907451661628	2,00 kg
B1	5907451661611	2,60 kg

## SNAP FRAMES BLACK

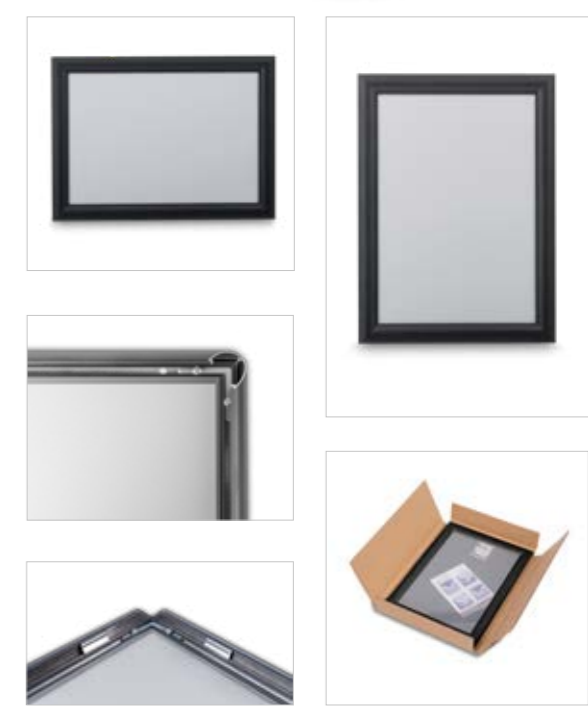

A4	5907451664872	0,45 kg
A3	5907451664865	0,65 kg
A2	5907451664858	1,15 kg
A1	5907451664841	1,90 kg
B3	5907451665787	0,95 kg
B2	5907451665794	2 kg
B1	5907451665800	2,6 kg

# SNAP FRAMES PREMIUM



- **aluminium profile: 32 mm**
- "clip-clap" system – quick and simple assembly and graphics exchange
- vertical or horizontal assembly
- poster cover with UV-filter protects the printout from fading graphic colours

- **Profilbreite (aluminium): 32 mm**
- "Clip-Clap" System – sofortige und einfache Montage und Austausch von Grafiken
- vertikale oder horizontale Montage
- Plakathülle mit UV-Filter schützt den Ausdruck vor dem Verblässen der Grafikfarben

- **profil large (aluminium): 32 mm**
- changement rapide de l'image grâce aux bords du cadre („clip-clap“)
- couche avec filtre UV protégeant l'impression de la perte de couleurs
- montage vertical ou horizontal



A3	5907451664230	1,20 kg
A2	5907451664223	1,85 kg
A1	5907451664216	2,80 kg

Recommended media and printing technology for this system:



# MAGNETIC FRAMES

## MAGNETIC

- simple and elegant design
  - glossy anti-reflective foil holds the printout with magnetic strips
  - assembly without tools
  - value for money
- einfaches und elegantes Design
  - die glänzende Antireflexionsfolie hält den Ausdruck mit Magnetstreifen
  - Montage ohne Werkzeuge
  - Preis-Leistungsverhältnis
- design simple et élégant
  - le film brillant anti-reflet maintient l'impression à l'aide de bandes magnétiques
  - montage sans outils
  - faible coût

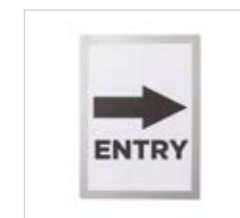

A5 (silver)	6956526031285
A4 (silver)	6956526031278
A3 (silver)	6956526031261
A4 (black)	5907451663424
A3 (black)	5907451662670

## MAGNETIC REWERS

- front-glued frame
  - double-sided
  - simple and elegant design
  - assembly without tools
- Vorne geklebt Rahmen
  - doppelseitig
  - einfaches und elegantes Design
  - montage ohne Werkzeuge
- cadre monté à l'avant
  - design simple et élégant
  - double face
  - assemblage sans outils



A4 (silver)	6956526031513
A3 (silver)	6956526031520
40x60 cm (silver)	6956526031537
A4 (black)	5907451665015



## MAGNETIC SAFETY

- magnetic frame in warning version
  - necessary in production halls, warehouses, parking lots and places under special supervision
  - simple and elegant design
  - glossy anti-reflective foil holds the printout with magnetic strips
  - assembly without tools
- magnetisches Rahmen in Warnung Version
  - unverzichtbar in Produktionshallen, Lagerhallen, Parkplätzen und Orten, die unter besonderer Aufsicht stehen
  - einfaches und elegantes Design
  - die glänzende Antireflexionsfolie hält den Ausdruck mit Magnetstreifen
  - Montage ohne Werkzeuge
- cadre magnétique en version d'avertissement
  - indispensable dans les halls de production, les entrepôts, les parkings et les zones de haute sécurité
  - un film brillant anti-reflet maintient l'impression grâce à des bandes magnétiques fixées sur ce film et sur le cadre
  - montage sans outils



A4	5907451663486
A3	5907451663479

Recommended media and printing technology for this system:



# DOOR SIGNS

## SONIC

- one of the most popular wall door signs on the market
  - quick assembly
  - popular "clip-clap" system – graphics change takes few seconds
  - anti-reflective film included
  - mounting with fixing bolts or double-sided tape
  - value for money
- eines der beliebtesten Wandtürschilder auf dem Markt
  - schnelle Montage
  - beliebtes „Clip-Clap“ – System – der Grafikwechsel dauert einige Sekunden
  - Antireflexfilm enthalten
  - Montage mit Befestigungsschrauben oder doppelseitigem Klebeband
  - Preis-Leistungsverhältnis
- l'une des plaques de porte les plus populaires sur le marché
  - rapidité de changement de l'étiquette („clip-clap“)
  - film anti-reflet inclus
  - la plaque peut être montée à l'aide des vis incluses dans le kit ou avec du ruban adhésif double face



A6	6956526031179
A5	6956526031162
A4	6956526031155

Recommended media and printing technology for this system:



## ELITE

- very elegant look
  - most frequently chosen for modern style interiors
  - graphic may be replaced by unscrewing two stand-offs holding two plexiglass sheets
  - use this system if you don't need to change the graphics frequently
- sehr eleganter Look
  - am häufigsten für moderne Innenräume gewählt
  - Die Grafik kann ersetzt werden, indem zwei Abstandhalter mit zwei Plexiglasplatten abgeschraubt werden
  - Verwenden Sie dieses System, wenn Sie die Grafiken nicht häufig ändern müssen
- une élégance exceptionnelle
  - souvent choisi pour les intérieurs modernes
  - pour changer l'étiquette indicative, il suffit de dévisser les entretoises retenant les deux plaques de plexiglas
  - utiliser ce système si vous n'avez pas besoin de modifier les fréquemment les graphiques

A6	6956526032121
148x148 mm	6956526032138
A5	6956526032145
A4	6956526032169

Recommended media and printing technology for this system:



## GERT

- modern design
  - classic ash-grey color which fits any interior design
  - graphics may be replaced with a single move, just by opening the plate clips
  - no tools required
- modernes Aussehen, einfaches und elegantes Design
  - klassische Aschefarbe, um alle Innenräume zu passen
  - der Austausch des Inhalts erfolgt durch das Öffnen der Schnellverschlüsse,
  - Keine Werkzeuge erforderlich
- série de plaques exceptionnellement élégantes qui se distinguent par leur aspect moderne
  - la couleur cendrée classique convenant à tous les intérieurs
  - vous pouvez changer l'étiquette indicative d'un seul geste et sans aucun outil, en ouvrant les fermoirs pression de la plaque



149x64 mm	6956526032084
149x105,5 mm	6956526032091
149x148,5 mm	6956526032107

Recommended media and printing technology for this system:



## PURO

- modern look
  - easy content exchange
  - made of a very thick aluminium profile
  - mounting with double-sided tape
- moderner Look
  - einfacher Inhaltsaustausch
  - aus einem sehr dicken Aluminiumprofil
  - Montage mit doppelseitigem Klebeband
- aspect moderne
  - échange facile du contenu
  - en profilé d'aluminium très épais
  - montage avec du ruban adhésif double face

180x50 mm	6956526031711
180x70 mm	6956526031728
210x90 mm	6956526031735

Recommended media and printing technology for this system:



## MANTA

- minimalistic look
  - suitable for interiors designed in bright – Scandinavian style
  - this holder is equipped with a white frame on which front plexiglass pane is installed (with clips)
- minimalistisches Design
  - Dieses Produkt ist besonders für helle Innenräume im skandinavischen Stil geeignet
  - Das Schild hat einen weißen Rahmen, auf den das vordere Plexiglas aufgesetzt wird (mit Schnellverschlüssen)
- aspect minimaliste
  - convient aux intérieurs conçus dans un style lumineux – scandinave
  - ce support est équipé d'un cadre blanc sur lequel est installé
  - la vitre avant en plexiglas est installée (avec des clips)

A6	6956526050989
A5	6956526050996
A4	6956526051009

Recommended media and printing technology for this system:



# ACRYLIC STANDS CRYSTAL

- 
  - double sided acrylic stand
  - ideal for placing on a table / counter in various public spaces, e.g. restaurants, banks, hotels
  - wide base ensures stability
  - versatile appearance
- 
  - doppelseitige acryl Ständer
  - ideal für die Platzierung auf dem Tisch / Theke in den Innenräumen von verschiedenen öffentlichen Räumen, wie Restaurants, Banken, Hotels
  - breite basis garantiert stabilität
  - universelles Aussehen
- 
  - support acrylique double face
  - idéal pour être placé sur des tables ou des comptoirs dans divers espaces publics, tels que les restaurants, les banques, les hôtels, etc.
  - la large base garantit la stabilité aspect neutre

Recommended media and printing technology for this system:





Paper  
Solvent, UV, Latex

	
A7	6956526050132
A6	6956526050156
A5	6956526050163
A4	6956526050170



# PLATINUM

- 
  - acrylic stand with a slight angle of inclination
  - minimalistic look
  - ideal for placing on a table / counter in the interiors of various public spaces, e.g. in banks, hotels, corporate receptions, etc.
  - wide base with interesting design guarantees stability
- 
  - acryl-Ständer mit leichtem Neigungswinkel
  - minimalistisches Design
  - ideal für die Platzierung auf dem Tisch / Theke in den Innenräumen der verschiedenen öffentlichen Räume, wie Banken, Hotels, Empfänge von Unternehmen, etc.
  - breite Basis mit interessantem Design garantiert Stabilität
- 
  - support en acrylique avec un léger angle d'inclinaison
  - design minimaliste
  - idéal pour une utilisation sur les tables/comptoirs dans les lieux publics tels que les banques, les hôtels, les bureaux de réception, etc.
  - la large base au design intéressant garantit la stabilité

Recommended media and printing technology for this system:







Paper  
Solvent, UV, Latex

	
A5	6956526053638
A4	6956526053645



# VISTA HORIZONTAL

- 
  - heavy acrylic stand with a broad base
  - elegant look
  - horizontal graphic presentation
  - double-sided
- 
  - Schwerer Acrylständer mit breiter Basis
  - Elegantes Aussehen
  - Horizontale grafische Darstellung
  - Doppelseitig
- 
  - support en acrylique solide avec une large base
  - design exceptionnellement élégant
  - présentation horizontale du contenu
  - double face

	
A6	6956526053775
A5	6956526053768
A4	6956526053751



Recommended media and printing technology for this system:



Paper  
Solvent, UV, Latex



# VISTA VERTIKAL

- 
  - heavy acrylic stand with a broad base
  - elegant look
  - vertikal graphic presentation
  - double-sided
- 
  - schwerer Acrylständer mit breiter Basis
  - elegantes Aussehen
  - vertikale grafische Darstellung
  - doppelseitig
- 
  - support en acrylique solide avec une large base
  - design exceptionnellement élégant
  - présentation horizontale du contenu
  - double face

	
A6	6956526053737
A5	6956526053720
A4	6956526053713

Recommended media and printing technology for this system:



Paper  
Solvent, UV, Latex





# ROD SYSTEMS

- popular ROD system for wall to wall hanging adv boards
- made from high quality aluminium
- minimalistic and elegant appearance
- long steel rope (300 cm/400 cm) included
- adjustable steel rope length
- anchors and screws for mounting included

- beliebtes ROD-System zum Aufhängen von Adv-Boards
- aus hochwertigem Aluminium gefertigt
- minimalistisches und elegantes Erscheinungsbild
- langes Stahlseil (300 cm/400 cm) enthalten
- einstellbare Stahlseillänge
- Anker und Schrauben zur Montage enthalten

- le système ROD populaire destiné à suspendre les panneaux publicitaires, fabriqué - en aluminium de haute qualité
- design minimaliste et élégant
- long câble en acier inclus (300 cm/400 cm)
- longueur de câble réglable
- chevilles et vis de fixation incluses

## WALL TO WALL SYSTEM

WAND ZU WAND SYSTEM  
SYSTÈME DE CÂBLES MUR-MUR

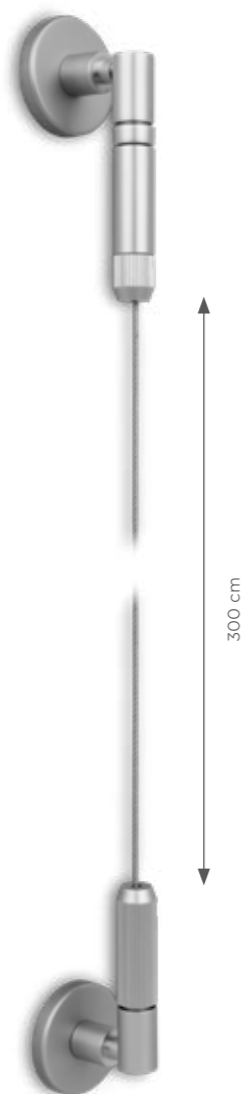

300 cm



5907451664490 0,5 kg ROD 300 cm

## WALL TO FLOOR/CEILING SYSTEM

WAND ZUM BODEN-/DECKENSYSTEM  
SYSTÈME DE CÂBLES MUR-SOL/PLAFOND

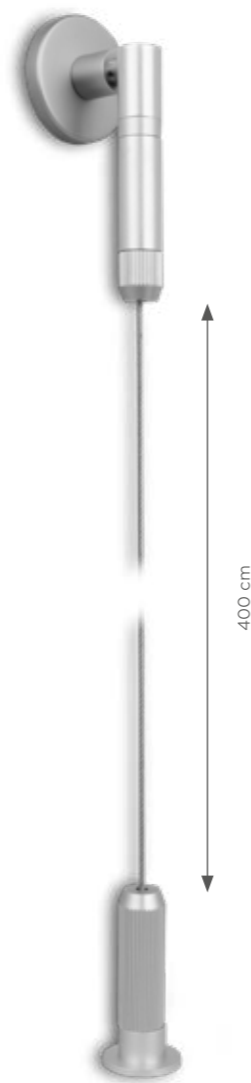

400 cm



5907451664513 0,4 kg ROD 400 cm

## CEILING TO FLOOR SYSTEM

DECKEN ZU BODEN SYSTEM  
SYSTÈME DE CÂBLES PLAFOND-SOL

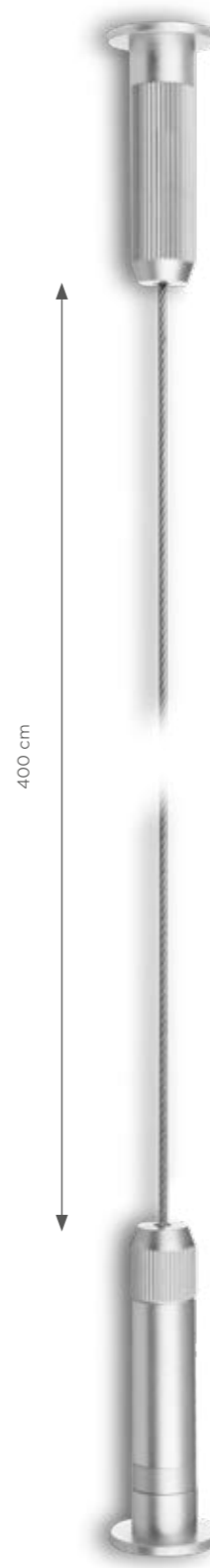

400 cm



5907451664506 0,3 kg ROD 400 cm

## CEILING TO BOARD SYSTEM

DECKEN-BORD SYSTEM  
SYSTÈME DE CÂBLES PLAFOND-PANNEAU

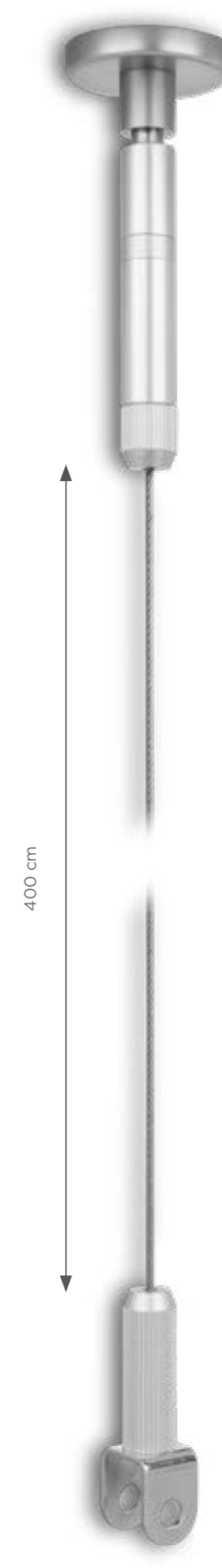

400 cm



5907451664520 0,4 kg ROD 400 cm

## ACCESSORIES



### SINGLE-SIDE BOARD HOLDER

EINSEITIGER BORDHALTER  
FIXATION DU PANNEAU  
- UNILATÉRALE



5907451664537 0,1 kg

### DOUBLE-SIDE BOARD HOLDER

DOPPELSEITIGER BORDHALTER  
FIXATION DU PANNEAU  
- BILATÉRALE



5907451664544 0,15 kg

## STANDOFFS WANDHALTERUNG ENTRETOISES



- designed for mounting all types of advertising boards
- made of aluminium
- high quality
- multiple sizes
- two color versions: black mat and silver satin

- entworfen, um alle Arten von Werbetafeln zu installieren
- aus Aluminium hergestellt
- hochwertige Verarbeitung
- mehrere Größen
- zwei Farbversionen: schwarze Matte und Silber Satin

- conçu pour le montage de tous types de panneaux d'affichage
- en aluminium
- de haute qualité
- plusieurs tailles disponibles
- deux versions de couleurs: noir mat et argent satiné

### SILVER SATIN



Size	Barcode	Product Code
13x13 mm		5907451664551
13x19 mm		5907451664575
15x20 mm		5907451664599
15x25 mm		5907451664612
19x19 mm		5907451664636
19x25 mm		5907451664650
25x29 mm		5907451664674
25x25 mm		5907451664698

### SILVER MAT



Size	Barcode	Product Code
13x13 mm		5907451668108
13x19 mm		5907451668115
15x20 mm		5907451668122
15x25 mm		5907451668139
19x19 mm		5907451668146
19x25 mm		5907451668153
25x19 mm		5907451668160
25x25 mm		5907451668177

### BLACK MAT



Size	Barcode	Product Code
13x13 mm		5907451664568
13x19 mm		5907451664582
15x20 mm		5907451664605
15x25 mm		5907451664629
19x19 mm		5907451664643
19x25 mm		5907451664667
25x19 mm		5907451664681
25x25 mm		5907451664704



PAVEMENT SIGNS

# AURORA

- aluminium profile: 25 mm
  - double-sided
  - very resistant to weather conditions
  - clip-clap system - quick graphics exchange
  - poster cover with UV-filter protects the printout from fading colours
- The set includes: stand Aurora in a carton box.

- Profilbreite (aluminium): 25 mm
  - doppelseitig
  - sehr langlebig Allwetter-Design
  - clip-Clap-System-sofortiger Ersatz von Grafiken
  - Plakathülle mit UV-Filter schützt den Ausdruck vor dem Verblässen der Grafikfarben
- Dieses Set enthält: Kundenstopper Aurora, Einzelkarton.

- profil large (aluminium): 25 mm
  - recto-verso
  - changement rapide de l'affiche (cadre clic-clac)
  - couverture dotée d'un filtre UV protégeant l'impression de la perte de couleurs
- Le kit comprend: un chevalet stop trottoir Aurora, une boîte en carton individuelle.

Recommended media and printing technology for this system: Paper Solvent, UV, Latex

# AURORA SILVER



A2	5907451662021	6,75 kg
A1	5907451662151	9,00 kg
A0	5907451662144	12,60 kg
B2	5907451662182	5,00 kg
B1	5907451662175	9,20 kg

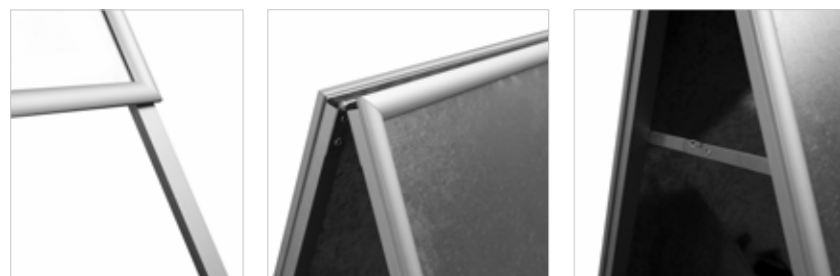

# AURORA BLACK

A2	5907451664384	6,75 kg
A1	5907451664377	9,00 kg

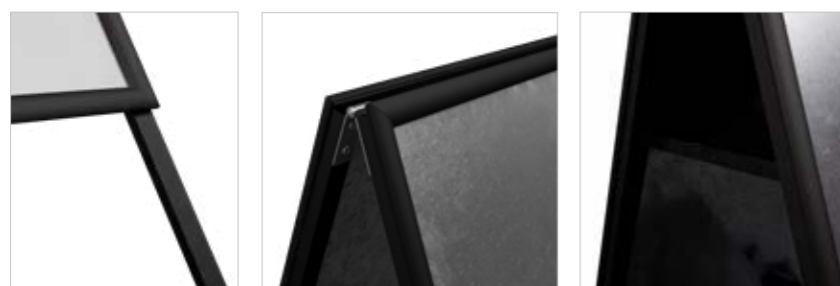

# SPIDER



- aluminium profile: 32 mm
  - extremely stable even in strong winds
  - double sided
  - very weather resistant
  - clip-clap system - quick graphics exchange
  - poster cover with UV-filter protects the printout from fading colours
- This set includes: stand Spider in individual box.

- Profilbreite (aluminium): 32 mm
  - extrem stabil auch bei starkem Wind
  - doppelseitig
  - sehr witterungsbeständig
  - System „clip-clap“ - sehr schneller Grafikaustausch
  - Plakathülle mit UV-Filter schützt den Ausdruck vor dem Verblässen der Grafikfarben
- Dieses Set enthält: Kundenstopper Spider, Einzelkarton.

- profil large (aluminium): 32 mm
  - chevalet stop trottoir très stable (cadre sur ressorts, pieds écartés) très résistant aux intempéries
  - changement rapide de l'affiche (cadre clic-clac)
  - recto-verso
  - couverture dotée d'un filtre UV protégeant l'impression de la perte de couleurs
- Le kit comprend: un chevalet stop trottoir Spider, une boîte en carton individuelle.



A1	5907451662205	8,8 kg

Recommended media and printing technology for this system: Paper Solvent, UV, Latex

# HAMPTON

- aluminium profile: 32 mm
  - base can be filled with water or sand
  - extremely stable even in strong wind
  - double sided
  - very weather resistant
  - clip-clap system - quick graphics exchange
  - poster cover with UV-filter protects the printout from fading colours
- This set includes: stand Hampton in a carton box.

- Profilbreite (aluminium: 32 mm)
  - die Basis kann mit Wasser oder Sand gefüllt werden
  - extrem stabil auch bei starkem Wind
  - doppelseitig
  - sehr witterungsbeständig
  - Clip-Clap-System - sehr schneller Grafikaustausch
  - Plakathülle mit UV-Filter schützt den Ausdruck vor dem Verblasen der Grafifarben
- Dieses Set enthält: Kundenstopper Hampton, Einzelkarton.

- profil large (aluminium): 32 mm
  - chevalet stop trottoir très stable (cadre sur ressorts, socle rempli d'eau)
  - poignée et roulettes facilitant le transport
  - changement rapide de l'affiche (cadre clic-clac)
  - recto-verso
  - couverture dotée d'un filtre UV protégeant l'impression de la perte de couleurs
- Le kit comprend: un chevalet stop trottoir Hampton, une boîte en carton individuelle.

Recommended media and printing technology for this system:



## HAMPTON SILVER



	Barcode	Weight
A1	5907451662014	15 kg
A0	5907451663554	22 kg
B2	5907451663325	18 kg
B1	5907451663561	13 kg



## HAMPTON BLACK



	Barcode	Weight
A1	5907451662199	15 kg
B2	5907451665756	13 kg



# HAMPTON PRO

NEW!

- aluminium profile: 40 mm
  - enhanced water resistance parameters
  - base can be filled with water or sand
  - handle and wheels for easy transport
  - extremely stable even in strong wind
  - double sided
  - clip-clap system - quick graphics exchange
  - thick poster cover with UV-filter protects the printout from fading colours
- The set includes: stand Hampton Pro in a carton box.

- Aluminiumrahmen: 40 mm
  - verbesserte Parameter für die Wasserbeständigkeit
  - die Basis kann mit Wasser oder Sand gefüllt werden
  - Griff und Räder für einfachen Transport
  - extrem stabil auch bei starkem Wind
  - doppelseitig
  - Clip-Clap-System - sehr schneller Grafikaustausch
  - Plakathülle mit UV-Filter schützt den Ausdruck vor dem Verblasen der Grafifarben
- Dieses Set enthält: Kundenstopper Hampton Pro, Einzelkarton.

- profil large (aluminium): 40 mm
  - paramètres de résistance à l'eau améliorés
  - la base peut être remplie d'eau ou de sable
  - chevalet stop trottoir très stable (cadre sur ressorts, socle rempli d'eau)
  - poignée et roulettes facilitant le transport
  - changement rapide de l'affiche (cadre clic-clac)
  - recto-verso
  - couverture dotée d'un filtre UV protégeant l'impression de la perte de couleurs
- Le kit comprend: un chevalet stop trottoir Hampton Pro, une boîte en carton individuelle.

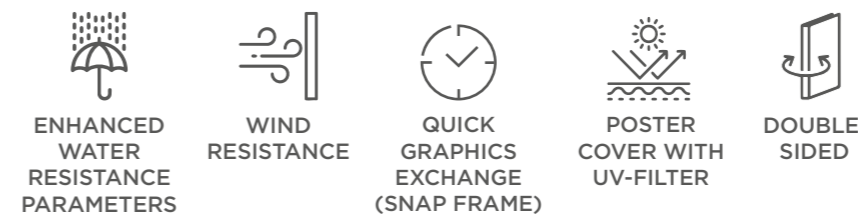

Recommended media and printing technology for this system:



## HAMPTON PRO SILVER



	Barcode	Weight
A1	5907451666784	17 kg



## HAMPTON PRO BLACK



	Barcode	Weight
A1	5907451666791	17 kg



# INFO STAND CHROMA

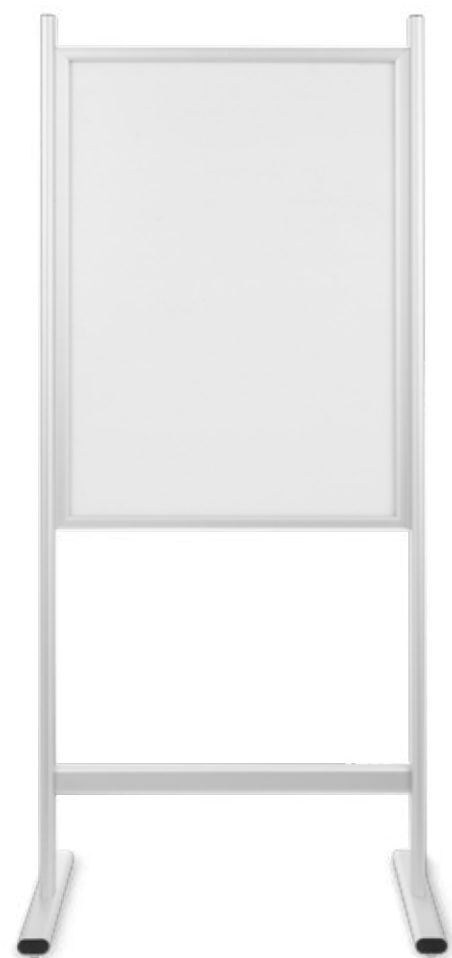

- aluminium profile: 25 mm
- double sided poster stand
- ideal for use in various public spaces
- easy installation of graphics via a sliding panel
- stable construction

This set includes: Info stand Chroma in individual box.

- Profilbreite (aluminium): 25 mm
- doppelseitige Plakatständer
- ideal für eine Vielzahl von öffentlichen Orten
- einfache Montage von Grafiken über ein Einschub-brett
- stabile Konstruktion

Dieses Set enthält: Chroma Stand im Einzelkarton.

- profil large (aluminium): 25 mm
- recto-verso
- construction en aluminium solide
- installation facile de graphiques grâce à un panneau coulissant

Le kit comprend: un support Chroma, une boîte en carton individuelle.



# INFO/MENU STAND PULADI



- adjustable angle, transparent frame
- stable steel base
- exchange of graphics by sliding it into an acrylic frame
- compact size when folded
- product intended for directions and presenting information

The set includes: Puladi stand, assembly kit with a hex key, individual box.

- verstellbarer, transparenter Rahmen
- stabiler Stahlsockel
- Austausch der Grafik durch Einschieben in einen Acrylrahmen
- kompakte Größe im zusammengeklappten Zustand
- Produkt, das u. a. zur Angabe von Richtungen und zur Darstellung von Informationen bestimmt ist

Dieses Set enthält: einen Ständer Puladi, ein Montagesatz mit Inbus, Einzelkarton.

- angle d'inclinaison du cadre réglable
- socle en acier très stable
- changement rapide de l'image insertion dans le cadre
- petites dimensions après le pliage
- le produit est parfait pour tout espace public pour présenter les informations ou indiquer la direction

Le kit comprend: un support Puladi, un jeu de montage avec clé Allen, une boîte en carton individuelle.

A4	6956526030080	2,2 kg	114 cm
A3	6956526030127	3,3 kg	120 cm

Recommended media and printing technology for this system:

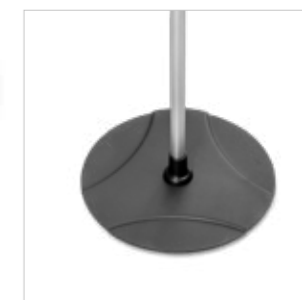
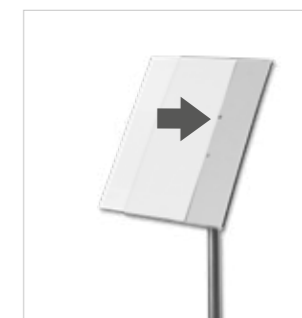

5907451664414 | 5,50 kg

## INFO/MENU STAND CLASSIC

- **aluminium profile: 25 mm**
- base made of steel - very stable
- adjustable frame angle
- clip-clap system - quick graphics exchange
- compact size when folded

The set includes: stand Classic, assembly kit with a hex key, individual box.

- **Profilbreite (aluminium): 25 mm**
- Base aus Stahl - sehr stabil
- verstellbarer Rahmen
- Clip-Clap-System - sehr schneller Grafikaustausch
- kompakte Größe im zusammengeklappten Zustand

Dieses Set enthält: einen Classic Ständer, ein Montagesatz mit Inbus, Einzelkarton.

- **profil large (aluminium): 25 mm**
- angle d'inclinaison du cadre réglable
- socle en acier très stable
- changement rapide de l'affiche (cadre clic-clac)
- petites dimensions après le démontage

Le kit comprend: un support Classic, un jeu de montage avec clé Allen, une boîte en carton individuelle.

A4	6956526030257	2,4 kg	111 cm
A3	6956526030264	3,5 kg	115 cm

Recommended media and printing technology for this system:



## INFO/MENU STAND STANDARD

- **aluminum profile: 25 mm**
- very elegant info stand
- designed, among others for restaurant menu, directions, presentation of information boards etc.
- clip-clap system - quick graphics exchange
- the frame can be positioned vertically or horizontally
- base made of iron

This set includes: stand Standard in a carton box.

- **Profilbreite (aluminium): 25 mm**
- sehr eleganter Informationsstand
- entworfen für Restaurantmenüs, Präsentation von Informationstafeln usw.
- Clip-Clap-System - sehr schneller Grafikaustausch
- der Rahmen kann senkrecht oder waagrecht aufgestellt werden
- Base aus Eisen

Dieses Set enthält: einen Standard Ständer im Einzelkarton.

- **profil large (aluminium): 25 mm**
- socle en fer
- possibilité de positionner le cadre verticalement ou horizontalement
- changement rapide de l'image à l'aide des bords du cadre (clic-clac)
- destiné entre autres: pour afficher les menus de restaurants, indiquer les directions, présenter les plaques d'information, etc.

Le kit comprend: un support Standard, une boîte en carton individuelle.

A4	5907451662106	3,70 kg	116 cm
A3	5907451664322	4,30 kg	121 cm

Recommended media and printing technology for this system:



## INFO/MENU STAND PREMIUM

- **aluminium profile: 25 mm**
- base made of iron
- very elegant info stand
- designed, among others for restaurant menu, directions, presentation of information boards etc.
- clip-clap system - quick graphics exchange
- the frame can be positioned vertically or horizontally

This set includes: stand Premium stand in a carton box.

- **Profilbreite (aluminium): 25 mm**
- Base aus Eisen
- sehr eleganter Informationsstand
- entworfen für Restaurantmenüs, Präsentation von Informationstafeln usw.
- Clip-Clap-System - sehr schneller Grafikaustausch
- der Rahmen kann senkrecht oder waagrecht aufgestellt werden

Dieses Set enthält: einen Premium Ständer im Einzelkarton.

- **profil large (aluminium): 25 mm**
- design élégant
- socle en fer
- possibilité de positionner le cadre verticalement ou horizontalement
- changement rapide de l'image à l'aide des bords du cadre (clic-clac)
- destiné entre autres: pour afficher les menus de restaurants, indiquer les directions, présenter les plaques d'information, etc.

Le kit comprend: un support Premium, une boîte en carton individuelle.

Recommended media and printing technology for this system:



### PREMIUM SILVER



A3	5907451664407	4,70 kg	126 cm
A2	5907451664391	5,00 kg	140 cm

### PREMIUM BLACK



A4	5907451667590	4 kg	125 cm
A3	5907451664438	4,70 kg	126 cm
A2	5907451664421	5,00 kg	140 cm

## METAL EASEL



- made of black powder painted metal
  - small size after folding
  - elegant case included
- The set includes: easel, transport case.

- aus schwarz pulverlackiertem Metall
  - kleine Größe nach dem Zusammenklappen
  - eleganter Koffer inklusive
- Das Set enthält: Staffelei, Transportkoffer.

- en métal peint par poudrage noir
  - petite taille après pliage
  - élégante mallette incluse
- Le kit comprend: un chevalet pliable, un étui élégant.



5907451663578



1,2 kg



# WOODEN PRODUCTS

## CHALKBOARD SIGNS CLASSIC

- **profile: 35 mm**
- elegant wooden frame
- versatile design-will fit into any space
- writing surface made of chalkboard
- ideal for restaurants and retail spaces

- **Profilbreite: 35 mm**
- eleganter Holzrahmen
- universelles Aussehen-passt zu jedem Raum
- schreibfläche aus Kreidebrett
- ideal für Restaurants und Einkaufsmöglichkeiten

- **profil large: 35 mm**
- cadre élégant en bois
- design polyvalent - s'adapte à tous les espaces
- la surface d'écriture sous forme de tableau noir est idéale
- pour les établissements de restauration et les espaces commerciaux

### CLASSIC



AVAILABLE COLOURS:



S	51x90 cm	5907451669808	3,5 kg
M	60x100 cm	5907451664780	4 kg
L	61x118 cm	5907451669785	5,5 kg
XL	72x160 cm	5907451669778	9 kg

### CLASSIC NATURAL

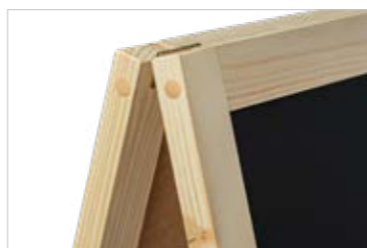
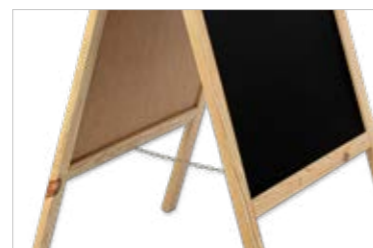

AVAILABLE COLOURS:



S	51x90 cm	5907451667484	3,5 kg
M	60x100 cm	5907451667347	4 kg
L	61x118 cm	5907451668535	5,5 kg
XL	72x160 cm	5907451667491	9 kg

## CHALKBOARD SIGN PRO WATERPROOF

- **profile: 60 mm**
- weather resistant due to varnish coating
- very durable construction
- stability ensured by the weight - 21 kg
- silver chain securing the legs

- **Profilbreite: 60 mm**
- witterungsbeständig durch Lackbeschichtung
- sehr langlebige Konstruktion
- stabilität gewährleistet durch das Gewicht - 21 kg
- silberkette zur Sicherung der Beine

- **profil large: 60 mm**
- résistant aux intempéries grâce à une couche de vernis
- production européenne
- stabilité assurée par le poids - 21 kg
- chaîne argentée fixant les pieds

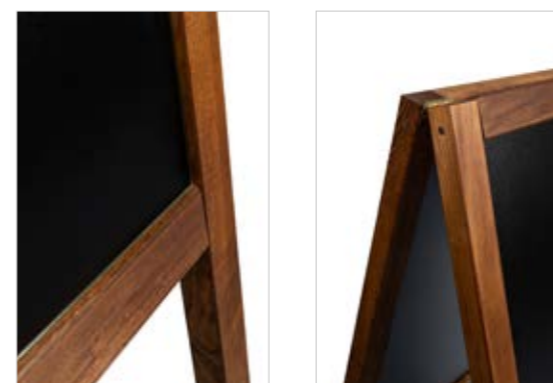

L	65x118 cm	5907451669747	21 kg

## LIQUID CHALK MARKERS

- A set of 8 markers with liquid chalk for chalkboard writing. A perfect replacement for dusty chalk. The set consists of 8 markers in following vivid colours: white, yellow, orange, pink, red, light blue, violet, green. The markers have a dual, reversible chisel: round and flat. This enables writing in bold. Markers are non-toxic, unscented, and easily removed with water.

- Ein Satz von 8 Markern mit flüssiger Kreide zum Schreiben an die Tafel. Ein perfekter Ersatz für staubige Kreide. Das Set besteht aus 8 Markern in folgenden leuchtenden Farben: weiß, gelb, orange, pink, rot, hellblau, violett, grün. Die Marker haben einen doppelten, umkehrbaren Meißel: rund und flach. Dies ermöglicht Fettschrift. Marker sind ungiftig, geruchlos und leicht mit Wasser zu entfernen.

- Lot de 8 marqueurs à craie liquide, pour écrire sur les tableaux noirs. Une excellente alternative à la craie traditionnelle poussiéreuse. Lot de 8 marqueurs aux couleurs vives : blanc, jaune, orange, rose, rouge, bleu, violet, vert. Chaque marqueur est doté d'une pointe à double face : ronde et plate. Cela permet d'écrire des lignes de différentes largeurs. Les marqueurs sont inodores et non toxiques et facilement lavables à l'eau.



5907451665480



# CHALKBOARDS



## KREIDETAFELN TABLEAUX À CRAIE



Classic chalkboards in wooden frames. **The frame profile is 3,5 cm.** The writing, black space is made of solid, durable HDF board. Chalk and liquid chalk markers can be used for writing on the HDF board. The chalkboards can be presented vertically and horizontally.

Klassische Tafeln in Holzrahmen. **Das Rahmenprofil beträgt 3,5 cm.** Die schreibende, schwarze Fläche ist aus massiver, strapazierfähiger HDF-Platte. Zum Beschriften der HDF-Platte können Kreide - und Flüssigkreidemarkers verwendet werden. Die Tafeln können vertikal und horizontal präsentiert werden.

Tableau noir à craie avec surface d'écriture en panneau HDF résistant, recouvert d'un vernis spécial. **Le profil du cadre est de 3,5 cm.** Vous pouvez écrire au tableau à la craie ou avec les marqueurs craie liquide. Le tableau peut être accroché verticalement ou horizontalement.



Frame size	Blackboard size	Barcode	Weight
47×60 cm	40×53 cm	5907451669686	1,5 kg
47×79 cm	40×72 cm	5907451669679	1,8 kg
60×87 cm	53×80 cm	5907451669662	2,1 kg
80×100 cm	73×93 cm	5907451669655	3 kg

# TABLE STANDS



## TISCHAUFSTELLER SUPPORTS À CRAIE

Double sided tabletop chalkboards in 3 sizes. The bottom is a brown wooden panel. Classic, plain look ensures fine presenting the stand in various spaces. The black board is made of durable HDF plate, that makes it possible to write with chalk or liquid chalk markers on it.

Doppelseitige Tafel tafeln in 3 Größen. Der Boden ist eine braune Holzplatte. Klassische, schlichte Optik sorgt für eine feine Präsentation des Standes in verschiedenen Räumen. Die schwarze Tafel besteht aus strapazierfähiger HDF-Platte, die es ermöglicht, mit Kreide oder flüssigen Kreidemarkern darauf zu schreiben.

Un support à craie double face pour présenter les informations est idéal pour être placé sur une table/un comptoir dans divers espaces publics, par exemple dans les restaurants, les banques, les hôtels, etc. La surface à craie (HDF résistant) permet un changement facile et rapide des informations notées. Le socle en bois garantit la stabilité du produit et son aspect élégant.



	Blackboard size	Barcode
A6	10×15 cm	5907451669624
A5	15×21 cm	5907451669631
A4	21×30 cm	5907451669648

# EASEL

A wooden easel will be perfect as a display in stores, galleries or restaurants. Classic look and stable construction are the distinctive features of this product. The easel has an adjustable tilt angle. The bottom shelf and upper handle ensure reliable hold of the frame or picture.

Die Staffelei aus Holz ist perfekt als Präsentation in Läden, Galerien oder Restaurants. Klassisches Aussehen und stabile Konstruktion sind die besonderen Merkmale dieses Produkts. Die Staffelei hat einen einstellbaren Neigungswinkel. Die untere Ablage und der obere Griff sorgen für einen zuverlässigen Halt eines Rahmens oder eines Bildes.

Chevalet en bois qui possède une structure très stable et légère. L'étagère inférieure et la poignée supérieure assurent un maintien solide du cadre ou du tableau. Une grande amplitude de réglage permet la présentation de tableaux de différentes tailles. Le chevalet peut être plié rapidement et sans effort ce qui facilite son rangement et son transport. Le produit constitue une solution idéale pour les personnes qui recherchent un présentoir classique et élégant pour un magasin, une galerie ou un restaurant.

## EASEL NATURAL



5907451669716

Chalkboard not included

## EASEL MAHOGANY



5907451669143

Chalkboard not included

## EASEL WHITE



5907451668979

Chalkboard not included

## EASEL BLACK



5907451668986

Chalkboard not included

## WOODEN LOUNGER

LIEGESTUHL

CHAISE LONGUE EN BOIS

- sturdy pine construction
- 3-stage backrest adjustment
- high load capacity (120 kg)
- special locking elements prevent the lounger from uncontrolled folding

The product meets PN-EN 581-1:2017-04 oraz PN-EN 581 1-2:2016-02 requirements.

- robuste Kieferkonstruktion
- 3-stufige Rückenlehnenverstellung
- Belastbarkeit von bis zu 120 kg
- spezielle Verriegelungselemente verhindern ein unkontrolliertes Zusammenklappen der Liege

Das Produkt erfüllt die Anforderungen von PN-EN 581-1:2017-04 und PN-EN 581 1-2:2016-02. Den Prüfbericht finden Sie unten.

- la construction solide en bois de pin
- réglage du dossier en 3 étapes
- capacité de charge jusqu'à 120 kg
- des éléments de verrouillage spéciaux empêchent le pliage incontrôlé de la chaise longue

Le produit répond aux exigences des normes PN-EN 581-1:2017-04 et PN-EN 581 1-2:2016-02. Vous trouverez le rapport de test ci-dessous.

## WOODEN LOUNGER (4 PIECES)

The set includes: lounger (4 pieces), screws, bulk carton box.

Das Set enthält: Liegestuhl (4 Stück), Schrauben, Kartonverpackung.

Le kit comprend: une chaise longue (4 pièces), des vis, un emballage tertiaire en carton.



Lounger material not included



5907451668788



10 kg

## WOODEN LOUNGER FOR SELF-ASSEMBLY



The set includes: lounger for self-assembly (1 piece), screws, blocking elements (6 pcs) with screws, assembly instructions, an individual carton box.

Das Set enthält: Liegestuhl zur Selbstmontage (1 Stück), Schrauben, Verriegelungselemente (6 Stück) mit Schrauben, Montageanleitung, Einzelkarton.

Le kit comprend: une chaise longue à monter soi-même (1 pièce), des vis, éléments de verrouillage (6 pièces) avec vis, une notice de montage, une boîte en carton individuelle.



Lounger material not included



5907451668795



2,5 kg



QUEUE BARRIER

## PREMIUM BARRIER

High quality barrier posts with a tape winding system. The post weight was raised to 7.5 kg, and the tape extended to 225 cm. The winding head is integrated with the post, and its replacement is very simple and quick. The tape used in the head is a car seat belt, extremely strong and durable (red colour - exchangeable).

Hochwertige Absperrpfosten mit Bandwickelsystem. Das Pfostengewicht wurde auf 7,5 kg erhöht und das Band auf 225 cm verlängert. Der Wickelkopf ist in den Pfosten integriert und kann sehr einfach und schnell ausgetauscht werden. Das im Kopf verwendete Klebeband ist ein Autositzgurt, extrem stark und langlebig (rote Farbe - austauschbar).

Poteaux de barrière de haute qualité avec enrouleur de sangle automatique. Le poids du poteau a été augmenté jusqu'à 7,5 kg et la sangle a été rallongée pour atteindre 225 cm. Grâce à son poids élevé, même avec une sangle aussi longue, le poteau reste très stable. L'enrouleur de sangle est intégré au poteau et son remplacement est très simple et rapide. La sangle utilisée dans l'enrouleur est une ceinture de sécurité de voiture. Le matériau est exceptionnellement solide et durable et il ne s'effilochera jamais.

## HOTEL BARRIER

Hotel barrier well known in many markets in the two most popular colors: gold and silver. Extremely stable, high quality. It will not only be a system to control people, but also an interior decoration for restaurants, clubs or hotels.

Hotelbarriere in vielen Märkten in den beiden beliebtesten Farben bekannt: Gold und Silber. Extrem stabil, hohe Qualität. Es wird nicht nur ein System zur Kontrolle von Menschen sein, sondern auch eine Innenausstattung für Restaurants, Clubs oder Hotels.

Poteaux cordon d'hôtel bien connus sur plusieurs marchés, disponibles dans deux des couleurs les plus populaires : or et argent. Extrêmement stables et de haute qualité. Ils ne seront pas seulement un élément de la gestion du flux de personnes, mais aussi une décoration intérieure pour les restaurants, les clubs ou les hôtels.



## PREMIUM BLACK



## PREMIUM CHROME



## ROYAL CHROME

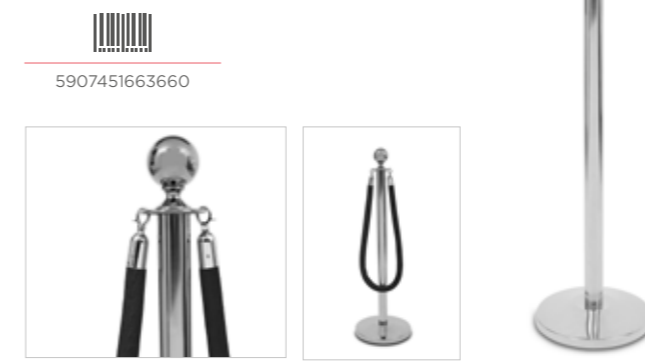

## MODERN CHROME

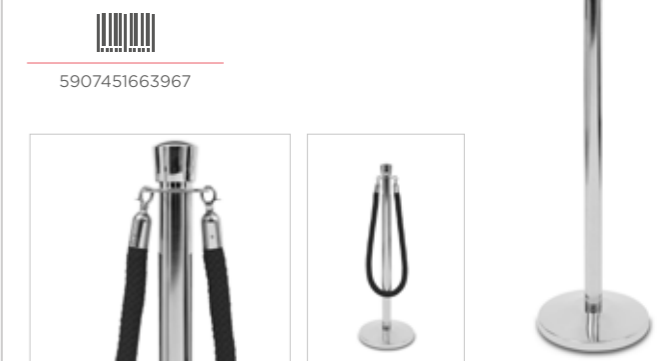

## ROYAL GOLD

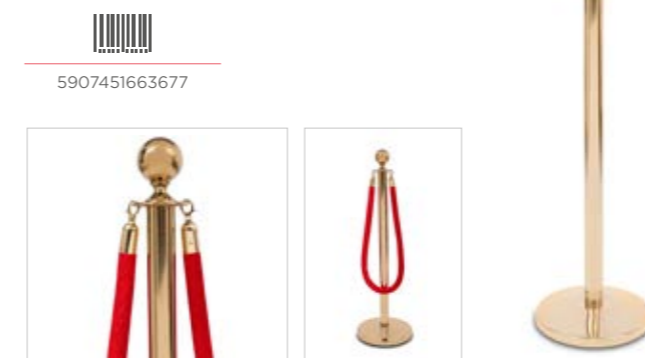

## MODERN GOLD

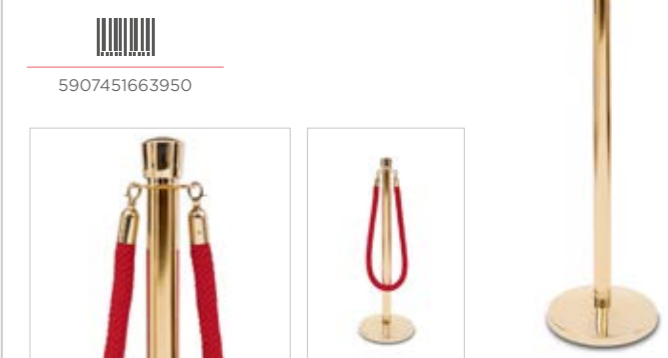

## PREMIUM WHITE



## REPLACEMENT HEADS

AUSTAUSCHKÖPFE  
ÉCHANGE DE TÊTES  
CONTRE DES POTEAUX



## VELVET BORDER

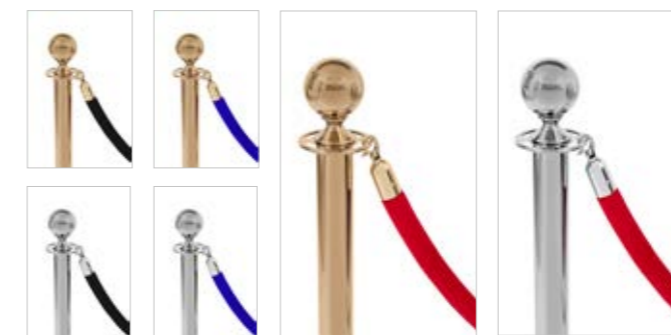

## LACED BORDER





Borders available with silver or gold clasps.  
Band mit Silber - oder Goldriegel erhältlich.  
Les bordures sont disponibles avec des claps argentés ou dorés.

## BARRIER POST INFO FRAME

ABSPERRPFOSTEN INFORMATIONSRAHMEN  
PORTE-AFFICHES POUR LES POTEAUX

 Double-sided A4 information frame applied on the top of barrier post. Available in two colors: chrome and black mat.

 Doppelseitiger A4-Informationsrahmen, der oben auf dem Absperrpfosten angebracht ist. Erhältlich in zwei Farben.

 Panneau d'information double face au format A4, fixé sur un poteau de barrière.

### INFO FRAME CHROME





### INFO FRAME BLACK



## WALL MOUNTED HEAD

WANDBASE  
SUPPORT MURAL

 A belt in another colour is available by purchasing a replacement head in our store.

 Das Band kann durch den Kauf eines Ersatzkopfes in unserem Shop gegen andere Farben ausgetauscht werden

 Support mural avec enrouleur pour rétracter la sangle. Il sera utile dans les endroits où il n'y a pas assez d'espace pour placer des poteaux. Vous pouvez remplacer la couleur de la sangle en achetant une tête de remplacement dans notre magasin.



	
black	5907451665053
red	5907451663318



FLAG POLES

# STANDARD POLE

One pole many shapes:  
(Example shapes)



- one pole - many shapes
- low cost pole
- quick assembly
- aluminium + fibreglass
- fits to all types of our bases

This set includes: Standard pole and taffeta sack.

- ein Mast-mehrere Formen
- niedriger Preis
- schnelle Installation
- aluminium + fibreglass
- geeignet für alle Arten von Grundlagen

Dieses Set enthält: Standard Mast und polyester Tasche

- construction en aluminium et en fibre de verre
- un mât = plusieurs formes
- installation rapide
- prix bas
- s'adapte à tous les types de bases

Le kit comprend: un mât Standard, un sac en polyester.

S	5907451662298	0,40 kg	290 cm
M	5907451662304	0,50 kg	350 cm
L	5907451662311	0,60 kg	450 cm
XL	5907451662328	0,80 kg	550 cm

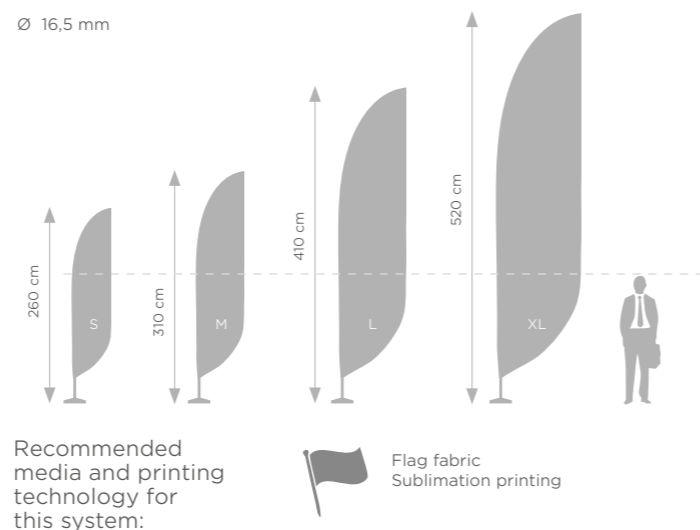

# PRO POLE

One pole many shapes:  
(Example shapes)



- one pole - many shapes
- mast made entirely of fibreglass
- high quality
- quick assembly
- fits to all types of our bases

This set includes: PRO pole and taffeta sack.

- ein Mast-mehrere Formen
- komplett aus Fiberglas
- hohe Qualität
- schnelle Installation
- geeignet für alle Arten von Grundlagen

Dieses Set enthält: PRO mast und polyester Tasche.

- construction en fibre de verre
- haute qualité
- un mât = plusieurs formes
- assemblage rapide
- s'adapte à tous les types de bases

Le kit comprend: un mât PRO, un sac en polyester.

S	5907451662335	0,50 kg	290 cm
M	5907451662342	0,60 kg	340 cm
L	5907451662359	0,70 kg	450 cm
XL	5907451662366	0,95 kg	560 cm

Recommended media and printing technology for this system:

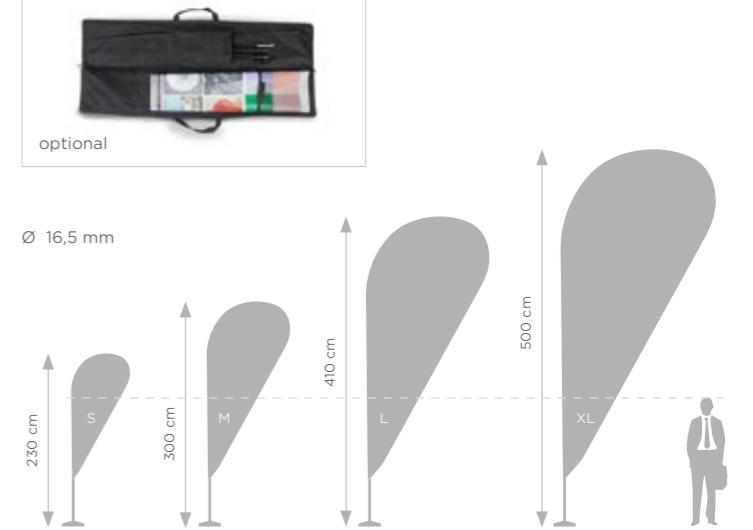

# TWISTER STANDARD

- full fibreglass
- high quality product
- fits to all kinds of our bases

This set includes: Twister system and a bag.

- komplett aus Fiberglas
- hohe Qualität
- geeignet für alle Arten von Grundlagen

Dieses Set enthält: Twister System und eine Tasche.

- construction en fibre de verre
- haute qualité
- s'adapte à tous les types de bases

Le kit comprend: système Twister, un sac en polyester.

S	TWIO00270	1,50 kg	270 cm
M	TWIO00320	1,60 kg	320 cm
L	TWIO00430	1,70 kg	430 cm
XL	TWIO00540	1,95 kg	540 cm

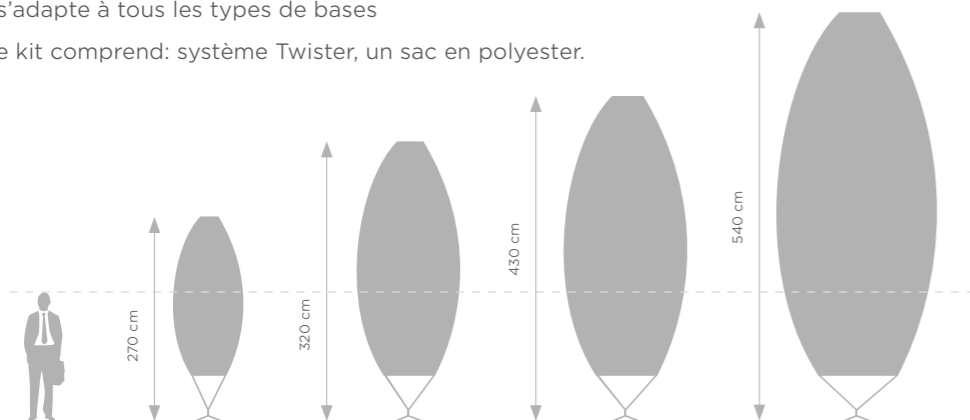

Recommended media and printing technology for this system:

Flag fabric  
Sublimation printing

Ø 16,5 mm



# H POLES

- large advertising space
- even in the absence of wind
- quick and easy assembly
- fits to all kinds of our bases
- full aluminium

This set includes: H pole and taffeta sack.

- große Werbebereich
- auch in abwesenheit von wind
- schnelle und einfache Installation
- geeignet für alle Arten von Grundlagen
- komplett aus Aluminium

Dieses Set enthält: H mast und polyester Tasche.

- grande surface publicitaire
- présentation de l'image imprimée même en l'absence de vent
- montage simple et rapide
- s'adapte à tous les types de bases
- construction en aluminium

Le kit comprend: un mât H, un sac en polyester.

Recommended media and printing technology for this system:

Flag fabric  
Sublimation printing

S	5907451663271	0,80 kg
M	5907451662441	0,90 kg
L	5907451663288	1,20 kg

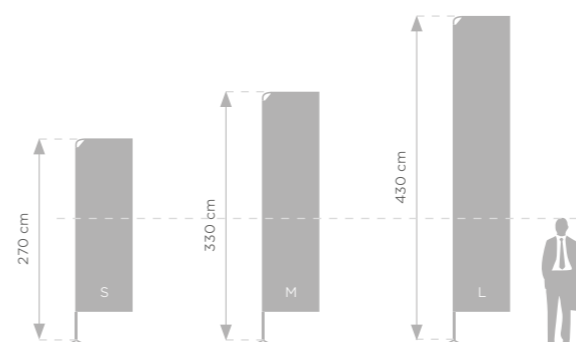

Ø 16,5 mm

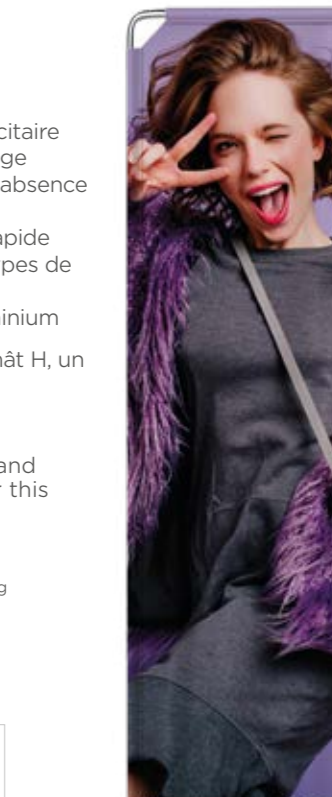

# TWISTER SHARK FIN

M	TWS000320	1,60 kg	320 cm
L	TWS000430	1,70 kg	430 cm
XL	TWS000540	1,95 kg	540 cm

This set includes: Twister system and a bag.  
Dieses Set enthält: mast und eine Tasche.

Le kit comprend: système Twister, un sac en polyester.

Recommended media and printing technology for this system:

Flag fabric  
Sublimation printing

Ø 16,5 mm

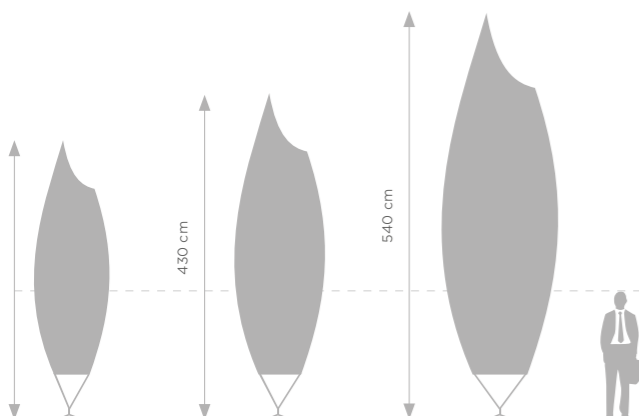

# AVENUE

Great for parking in shopping centers, car dealerships, alleys and city promenades. This set includes: upper and lower double pole, clamps, rubber pads, zips to protect flag/banner.

Ideal für Parkplätzen von Einkaufszentren, Autohäusern, Gassen und städtischen Fußgängerzonen. Dieses Set enthält: Oberer und unterer Mast, Klemmen, Gummipuffer, Kabelbinder.

Ce produit devient de plus en plus populaire, notamment pour l'utilisation dans les parkings des centres commerciaux, chez les concessionnaires automobiles, sur les avenues et les promenades urbaines. Le kit comprend: une potence supérieure et inférieure, des pinces, des tampons en caoutchouc, des fermetures éclair pour protéger le drapeau/la bannière.

Recommended media and printing technology for this system:

Flag fabric  
Sublimation printing

Coated Frontlit  
Solvent, UV, Latex

Single sided	66 cm 5907451663523
Double sided	66 cm 5907451663530
Single sided	80 cm 5907451667705
Double sided	80 cm 5907451667712

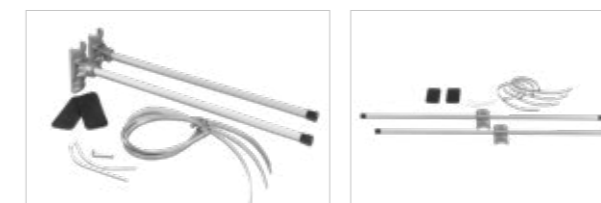

Ø 16,5 mm



# POLE BASE

## PLATE

PLATTE  
PLATINE

- square plate made of heavy cast iron
- perfect base and stabilization for every flag
- base mounted to the ground using pins
- hollow handle makes it easy to carry
- schwere Gusseisen quadratische Platte
- perfekte Basis und Stabilisierung für jede Flagge
- die Basis wird mit Stiften auf den Boden montiert
- Griff für den einfachen Transport
- plaque carrée en fonte lourde
- base et stabilisation idéales pour tout drapeau
- base fixée au sol à l'aide d'épingles
- poignée creuse pour faciliter le transport



Weight	Barcode	Dimensions
4 kg	5907451661765	30x30 cm
6 kg	5907451661772	35x35 cm
8 kg	5907451661789	39x39 cm
12 kg	5907451661796	48x48 cm

Pin Ø 16,5 mm

## PLATE WITH RUBBER FEETS

PLATTE MIT GUMMIFÜSSEN  
PLAQUE AVEC PIEDS EN CAOUTCHOUC

- thanks to the rubber feets, it is ideal for use in buildings and on sidewalks
- with rubber feets, the plate does not slip and is stays stable
- ideal für den Einsatz in Innenräumen von Gebäuden und auf Gehwegen
- mit Gummifüßen ist die Platte rutschfest und stabil
- grâce à ses pieds en caoutchouc, il est idéal pour une utilisation dans les bâtiments et sur les trottoirs
- grâce aux pieds en caoutchouc, la plaque ne glisse pas et reste stable

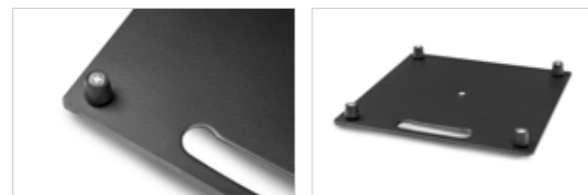

Weight	Barcode	Dimensions
4 kg	590745166176N	30x30 cm
6 kg	590745166177N	35x35 cm
8 kg	590745166178N	39x39 cm
12 kg	590745166179N	48x48 cm

Pin Ø 16,5 mm

## ROTATOR

- makes it easy to rotate the flag
- fits all types of poles.
- erleichtert das Drehen der Flagge
- geeignet für alle Masten
- grâce à l'utilisation du Rotateur, le mât tournera plus librement dans le sens du vent
- s'adapte à tous les types de mâts

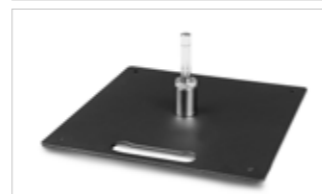

Pin Ø 16,5 mm



5907451661840

## FLAT CROSS

FLACHE KREUZ  
PIED EN CROIX PLAT

- for use on flat and soft grounds
- can be attached to the ground with pins
- can be additionally loaded with a water bag
- für den Einsatz auf flachem und weichem Untergrund
- kann mit Stiften am Boden befestigt werden
- kann zusätzlich belastet sein mit Wasserbeutel
- a utiliser sur sol plat ou meuble
- elle peut être fixée avec des broches
- la base peut aussi être lestée avec une charge roue d'eau



Barcode	Weight	Dimensions	Pin
5907451661857	2,3 kg	60x53 cm	Pin Ø 16,5 mm

## TUBE CROSS

ROHRE KREUZ  
PIED EN CROIX

- elegant base designed mainly for indoor interiors
- can be additionally loaded with a water bag
- elegante Basis, vor allem für den Innenraum
- kann zusätzlich belastet sein mit Wasserbeutel
- base métallique élégante pour mâts de drapeau
- à l'extérieur, lestez la base avec une charge roue d'eau pour augmenter la stabilité du système

### TUBE CROSS GREY



Barcode	Weight	Dimensions	Pin
5907451661864	1,4 kg	82x70 cm	Pin Ø 16,5 mm

### TUBE CROSS BLACK



Barcode	Weight	Dimensions	Pin
5907451669044	1,4 kg	82x70 cm	Pin Ø 16,5 mm

## WATER BAG

WASSERBEUTEL  
CHARGE ROUE D'EAU

- additional load
- after filled with water, it reaches a weight of up to 10 kg
- particularly suitable for high poles.
- zusätzliche Belastung für die Grundlagen
- beim Füllen mit Wasser erreicht ein Gewicht von bis zu 10 kg
- besonders geeignet für hohe masten
- charge roue d'eau ronde utilisée pour lester les bases
- lorsqu'elle est remplie d'eau, elle peut peser jusqu'à 10 kg
- surtout utile pour fixer des drapeaux hauts



Barcode	Weight	Dimensions
5907451661871	0,5 kg	Ø 50 cm

Ø 50 mm



# POLE BASE

## WATER TANK WASSERKANISTER PIED PARASOL

- 🇬🇧
  - bestseller
  - made of thick plastic with a terminal hole for the mast
  - after filled with water, it can weigh up to 20 kg
- 🇩🇪
  - Bestseller
  - aus dickem Kunststoff mit Klemmloch für Mast
  - wenn es mit Wasser gefüllt ist, kann es bis zu 20 kg wiegen
- 🇫🇷
  - best-seller
  - fabriqué en matière plastique épaisse avec un trou de serrage pour le mât
  - une fois remplie d'eau, elle peut peser jusqu'à 20 kg



5907451663189

0,40 kg

## CARBASE AUTOBASE PIED DE VOITURE

- 🇬🇧
  - metal base designed for salons and car stores
  - mounted under the car wheel
  - optionally a rotator can be used
- 🇩🇪
  - metallbasis für Autohäuser
  - es ist eine Luftwaffenbasis, unter Rädern von Autos
  - rotator kann optional angewendet werden
- 🇫🇷
  - base métallique conçue pour être placée chez les concessionnaires automobiles
  - monté sous la roue de la voiture
  - un rotateur peut être utilisé en option



5907451661925

1,6 kg

Pin Ø 16,5 mm

## BAYONET BAJONETT PIED PIQUET

- 🇬🇧
  - bestseller
  - designed for fixing poles to soft grounds
  - made of stainless steel
  - equipped with a rotator
- 🇩🇪
  - Bestseller
  - um Masten an weichen Boden zu befestigen
  - aus Edelstahl gefertigt
  - ausgestattet mit rotator
- 🇫🇷
  - best-seller
  - qui fixent les mâts au sol meuble
  - fabriqué en acier inoxydable
  - équipé d'un rotateur



5907451661888

0,95 kg

Rotator Ø 16,5 mm



## PIED PIQUET TWIN BAJONETT TWIN PIED PIQUET TWIN

- 🇬🇧
  - improved version of the Bayonet
  - this base has an additional impactor that prevents the Bayonet from rotating and destabilizing
- 🇩🇪
  - verbesserte Version des Bajonetts
  - die Basis hat einen zusätzlichen Schlag, der verhindert, dass sich das Bajonett dreht und es destabilisiert
- 🇫🇷
  - version améliorée du pied piquet
  - la base dispose d'un poinçon supplémentaire qui empêche la rotation et la déstabilisation du pied piquet



5907451661895

1,25 kg

Rotator Ø 16,5 mm

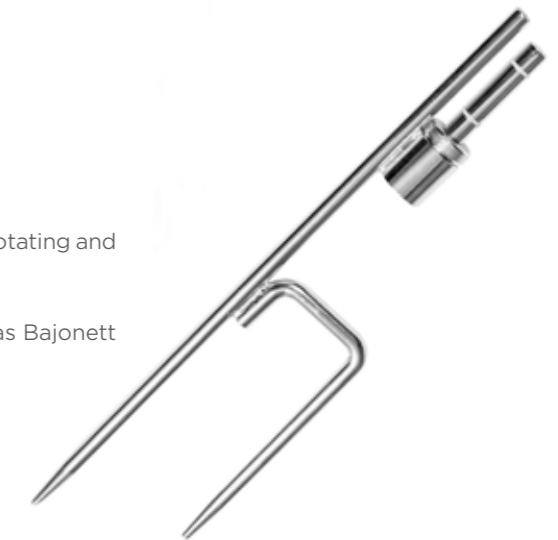

## DRILL DRILL PIED FORANT

- 🇬🇧
  - perfect for fastening poles to grass and sand
  - it has practical, folding handles that help screw the base to the ground
  - made of plastic, includes a rotator
- 🇩🇪
  - geeignet für die Befestigung von Masten an grasbewachsenen und sandigen Flächen
  - es hat praktische Klappgriffe, die helfen, die Basis auf den Boden zu befestigen
  - aus Kunststoff, hat einen Rotator
- 🇫🇷
  - le pied forant convient à la fixation de mâts dans le sable et la pelouse
  - il est doté de poignées pliables pratiques qui facilitent le vissage de la base au sol
  - le pied forant est fabriqué en matière plastique durable



5907451661918

0,7 kg

Rotator Ø 16,5 mm





## ROTATORS

### ROTATOR 90°

- 🇬🇧
  - integrated with a cast iron plate
  - ability to attach the base to a hard surface
  - set does not include dowels and fastening screws
- 🇩🇪
  - integriert mit gusseisen platte
  - möglichkeit der Befestigung der Basis an festem Boden
  - nicht enthalten dübel und Befestigungsschrauben
- 🇫🇷
  - intégré dans la plaque en fonte
  - la base peut être fixée sur une surface dure
  - chevilles et vis de fixation non incluses



Ø 16,5 mm



5907451661932



0,80 kg

### ROTATOR 45°

- 🇬🇧
  - used for attaching the poles to the wall
  - the set does not include dowels and fastening screws
- 🇩🇪
  - wird verwendet, um Masten an der Wand zu befestigen
  - Dübel und Befestigungsschrauben sind nicht enthalten
- 🇫🇷
  - utilisé pour fixer les mâts au mur
  - intégré dans la plaque en fonte
  - chevilles et vis de fixation non incluses



Ø 16,5 mm



5907451661949



0,80 kg

### ROTATOR

- 🇬🇧
  - made of stainless steel
  - a great replacement for standard mandrels used in such bases as: plate, flat cross, auto base
  - allows free rotation of the mast in accordance with the direction of the wind
- 🇩🇪
  - aus Edelstahl gefertigt
  - ausgezeichneter ersatz für standard-Dorn in basen wie: Platte, Kreuz, Auto basis
  - ermöglicht es dem Mast, sich frei entsprechend der Windrichtung zu drehen
- 🇫🇷
  - en acier inoxydable
  - remplace avantageusement les goupilles standard dans les bases telles que les plaques, les barres transversales plates, les bases auto
  - permet au mât de tourner librement dans la direction du vent



Ø 16,5 mm



5907451661840



0,45 kg



## TENT FRAMES

ZELTRAHMEN  
CADRE DE TENTE



- tent racks made of two types of materials: steel or aluminium
  - several sizes available
  - Everest - lightweight design, ideal for frequent change of location
  - Blanc - heavy, durable construction, powder coated white
- The set includes: foldable tent frame, mounting accessories, trolley bag.

- Zelte aus zwei Arten von Materialien: Stahl oder Aluminium
  - viele Größen verfügbar
  - Everest - leichteres Design, ideal für häufige Standortwechsel
  - Blanc - schwere, stabile Konstruktion, pulverbeschichtet in weißer Farbe
- Das Set enthält: Faltbares Zeltgestell, Montagezubehör, eine Transporttasche auf Rädern.

- cadres de tentes fabriquées en deux types de matériaux: acier ou aluminium
  - disponibles en plusieurs tailles
  - Everest - construction plus légère, idéale pour les déplacements fréquents.
  - Blanc - construction lourde et durable, peinte en blanc
- Le kit comprend: un cadre de tente pliable, accessoires de montage, un sac de transport.

BLANC (steel) 2,5x2,5	5907451661697	23 kg
BLANC (steel) 3x3	5907451661703	25 kg
BLANC (steel) 3x4,5	5907451661710	32 kg
BLANC (steel) 3x6	5907451661727	44 kg
EVEREST (aluminium) 3x3	5907451661734	17 kg
EVEREST (aluminium) 3x4,5	5907451661741	21 kg
EVEREST (aluminium) 3x6	5907451661758	32 kg

Print assembly modules:

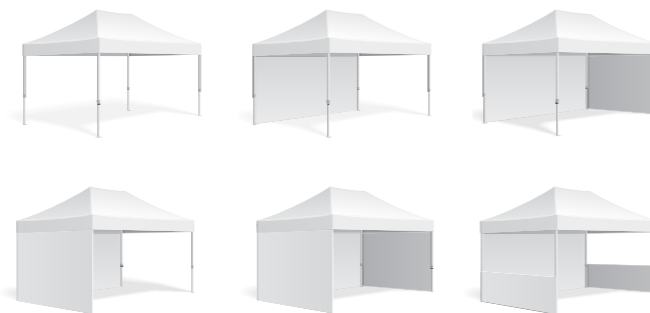



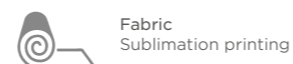







Recommended media and printing technology for this system:



## TENT CANOPY

DACH FÜR ZELTE

TOIT POUR CADRE DE TENTE

- |  |   |  |
|--|---|--|
| <ul style="list-style-type: none"> <li> waterproof</li> <li> durable colours (resistant to UV radiation)</li> <li> resistant to tearing (polyester 250-270 g)</li> </ul> | <ul style="list-style-type: none"> <li> wasserdicht</li> <li> dauerhafte (UV-beständige Farben)</li> <li> Reissfest (aus Polyester 250-270 g)</li> </ul> | <ul style="list-style-type: none"> <li> imperméable à l'eau</li> <li> résistance accrue à la déchirure (en polyester 250-270 g)</li> <li> facile à nettoyer</li> <li> couleurs durables (résistantes aux rayons UV)</li> </ul> |
|--|---|--|



		
3x3 white	5907451666272	3,9 kg
3x3 blue	5907451666289	3,9 kg
3x3 black	5907451666302	3,9 kg
3x3 red	5907451666296	3,9 kg
3x4,5 white	5907451666760	5 kg
3x4,5 blue	5907451666746	5 kg
3x4,5 black	5907451666777	5 kg
3x4,5 red	5907451666753	5 kg
3x6 white	5907451666715	8 kg
3x6 blue	5907451666739	8 kg
3x6 black	5907451666708	8 kg
3x6 red	5907451666722	8 kg

## ACCESSORIES

### HORSESHOE (of cast iron)



	
5907451661963	5 kg

### WATER TANK FOR TENT LEGS (of plastic)



	
5907451669990	1 kg + 14 l

### SANDBAG SINGLE



	
5907451663332	0,1 kg + 12 kg

### SANDBAG DOUBLE



	
5907451661987	0,3 kg + 18 kg

### FLAG BASE



	
5907451661956	1 kg

### HALFBAR (of aluminium)



		
3 m	5907451661994	1,2 kg
4,5 m	5907451662007	1,6 kg



EVENT ADV FURNITURE

# TABLES

- solid construction (polyethylene + steel)
- perfect for outdoor event
- non-slips pads on legs
- foldable
- special handle ensures easy transport (122, 180x75)

- solide Konstruktion (Polyethylen + Stahl)
- perfekt für Veranstaltungen im Freien
- rutschfeste Polster an den Beinen
- faltbar
- spezieller Griff für einfachen Transport (122, 180x75)

- construction robuste (polyéthylène + acier)
- idéal pour les événements en plein air
- embouts antidérapants
- pliable
- poignée spéciale pour faciliter le transport (122, 180x75)

## COCKTAIL TABLE 80

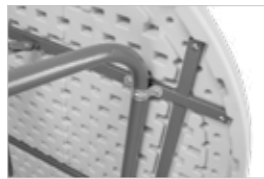

5907451664957 | 8 kg

## EVENT TABLE 180x75

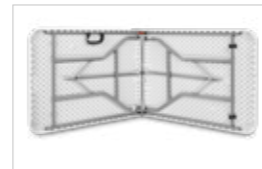

5907451664988 | 12 kg

## EVENT TABLE ROUND 122

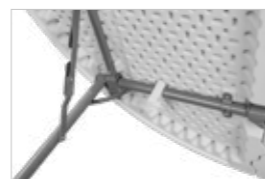

5907451664964 | 11 kg

# TABLE HEADER

- simple assembly
- great, original advertising area
- header mounted to rectangular tables
- einfache Montage
- tolle, originale Werbefläche
- titel für rechteckige Tische
- grande surface publicitaire originale
- montage de la tête de lit sur des tables rectangulaires
- l'image est installée sur la construction du topper de la même manière qu'on „enfile une chaussette“



5907451664971 | 1,5 kg

# TABLECLOTH

- flexible tablecloth
- made of polyester and elastine
- washable, no need to be ironed
- Dehnbar
- aus Polyestermaterial mit hohem Elasthan-Anteil
- waschbar, kein Bügeln erforderlich
- elle ne se plisse pas
- elle est lavable et ne nécessite pas de repassage
- élastique

## TABLECLOTH 80



white 5907451664926 | 0,5 kg  
black 5907451665220 | 0,5 kg

## TABLECLOTH 122



white 5907451664933 | 0,5 kg  
black 5907451665213 | 0,5 kg

## TABLECLOTH 180



white 5907451664940 | 0,5 kg  
black 5907451665206 | 0,5 kg

## CHAIRS

- lightweight, stable construction
- made of polyethylene and steel
- non-slips pads on legs
- foldable

- leicht, stabil Konstruktion
- aus Polyethylen und Stahl
- rutschfeste Polster an den Beinen
- faltbar

- construction légère et stable
- en polyéthylène et en acier
- patins antidérapants
- pliable

### FOLDING CHAIR



5907451665190 | 4,5 kg

### COCKTAIL CHAIR



5907451666241 | 5,5 kg

## COCKTAIL CHAIR COVER

- perfectly fitted
- made of polyester and elastine
- washable, no need to be ironed

- perfekt abgestimmt
- aus Polyester material mit hohem Elasthan-Anteil
- waschbar, kein Bügeln erforderlich

- parfaitement ajusté
- elle ne se plisse pas
- elle est lavable et ne nécessite pas de repassage
- élastique (en polyester et élastine)



white	5907451666258	0,28 kg
black	5907451666265	0,28 kg